

WAR DEPARTMENT

Rushy Dir. in 92/2

SIGNAL CORPS
FIELD MANUAL

*

AIRCRAFT WARNING SERVICE

August 3, 1942

REFERENCE USE
ONLY

NOT TO BE TAKEN FROM LIBRARY

REGRADED UNCLASSIFIED BY
AUTHORITY OF DOD DIR. 5200. 1 R

BY RAMERS ON 81103

~~SECRETED~~
SIGNAL CORPS
FIELD MANUAL

AIRCRAFT WARNING SERVICE

CHANGES |
No. 1 |

WAR DEPARTMENT,
WASHINGTON, March 10, 1943.

FM 11-25, August 3, 1942, is changed as follows:

■ 34. REPORTING PLATOON

* * * * *

b. Operating detail and power-plant detail.—The reporting platoon * * * the power-plant detail. The personnel of these two details are responsible for the actual installation and operation of the mobile radar equipment. They are also responsible for accomplishing minor repairs, adjustments, and replacements (maintenance in first echelon) and such more extensive repairs, adjustments, and replacements (maintenance in second echelon) as may be accomplished by use of hand tools and the mobile equipment issued to the unit. The operating detail * * * supply truck K-31.

* * * * *

[A. G. 062.11 (3-1-43).] (C 1, Mar. 10, 1943.)

BY ORDER OF THE SECRETARY OF WAR:

G. C. MARSHALL,

Chief of Staff.

OFFICIAL:

J. A. ULIO,

Major General,

The Adjutant General.

~~RESTRICTED~~

FM 11-25

SIGNAL CORPS
FIELD MANUAL



AIRCRAFT WARNING SERVICE



UNITED STATES
GOVERNMENT PRINTING OFFICE
WASHINGTON : 1942

WAR DEPARTMENT,
WASHINGTON, August 3, 1942.

FM 11-25, Signal Corps Field Manual, Aircraft Warning Service, is published for the information and guidance of all concerned.

[A. G. 062.11 (6-11-42).]

BY ORDER OF THE SECRETARY OF WAR:

G. C. MARSHALL,
Chief of Staff.

OFFICIAL:

J. A. ULIO,
Major General,
The Adjutant General.

DISTRIBUTION:

D (2); IC and H (10).

(For explanation of symbols see FM 21-6.)

TABLE OF CONTENTS

	Paragraphs	Page
CHAPTER 1. General.		
SECTION I. Purpose, definitions, and refer- ences-----	1-3	1
II. Missions, functions, and responsi- bility-----	4-7	2
CHAPTER 2. Organization.		
SECTION I. General-----	8	6
II. Factors affecting organization-----	9	6
III. Military units-----	10-27	8
IV. Nonmilitary agencies-----	28-29	19
CHAPTER 3. Observation systems.		
SECTION I. Mechanical-----	30-35	22
II. Nonmechanical-----	36-37	29
III. Messages and their transmission-----	38-41	34
IV. Installation of information and filter centers-----	42-48	38
CHAPTER 4. Signal communication systems.		
SECTION I. General-----	49-56	47
II. Communication installation-----	57-62	51
CHAPTER 5. Operations.		
SECTION I. Operation of information and filter centers-----	63-94	53
II. Duties of information and filter center personnel-----	95-111	72
APPENDIX. Model forms-----		94
INDEX-----		109

~~RESTRICTED~~

SIGNAL CORPS FIELD MANUAL

AIRCRAFT WARNING SERVICE

CHAPTER 1

GENERAL

	Paragraphs
SECTION I. Purpose, definitions, and references.....	1-3
II. Missions, functions, and responsibility.....	4-7

SECTION I

PURPOSE, DEFINITIONS, AND REFERENCES

■ 1. **PURPOSE.**—The purpose of the manual is to outline the Aircraft Warning Service and its agencies, to prescribe its mission and the responsibilities of various agencies concerned, to describe its functions, to cover the organization of its agencies, the observation and signal communication systems, and to prescribe operating procedures for the service. Variations from standard equipment and procedure are authorized where such variations are made mandatory by local conditions. This manual is based upon Field Service Regulations (FM 100 series) and is supplementary to FM 24-5 and FM 11-5.

■ 2. **DEFINITIONS.**—*a. Aircraft Warning Service.*—The Aircraft Warning Service is an organization, the chief function of which is to supply early information of enemy aircraft in the form desired by the interceptor commander.

b. Interceptor commander.—The interceptor commanders are responsible for the protection of their respective territorial commands by denying the use of air space to hostile aviation.

c. Information center.—The information center is a military installation in a region to which all reports of observations or detections of aircraft entering or operating in the area are submitted for identification. It is operated so that rapid identification of hostile aircraft will be made and the proper action employed to intercept and attack the enemy prior to the accomplishment of his mission.

d. Nonmilitary agencies.—Agencies composed of volunteers, organized by civilian defense councils for the purpose of aiding the Aircraft Warning Service.

e. Passive air defense.—Passive air defense takes place at the surface objective or area against which the enemy's air operations are directed. It includes all measures taken to render surface objectives less susceptible to hostile observation or bombardment, to control and protect personnel and material, and to restrict any activity that constitutes a direct aid to the enemy.

f. Active air defense.—Active air defense takes place in the air space through which enemy aircraft move. It is provided by aircraft, principally interceptor pursuit; projectiles fired from the ground by antiaircraft artillery; and obstacles, principally barrage balloons. Active air defense may take either of two forms; local air defense or general air defense.

g. Local air defense.—Local air defense provides air defense for a specific objective or relatively small area.

h. General air defense.—General air defense provides for the defense of the air space over a relatively large area which contains a number of potential objectives.

■ 3. FURTHER REFERENCE.—*a.* The publications listed below contain general or specific reference to the subject of Aircraft Warning Service:

FM 11-5, Missions, Functions, and Signal Communication in General.

FM 24-5, Signal Communication.

b. For a complete list of War Department training publications, see FM 21-6.

SECTION II

MISSIONS, FUNCTIONS, AND RESPONSIBILITY

■ 4. MISSIONS.—The mission of the Aircraft Warning Service is to observe the movement of aircraft and to collect and exhibit the information obtained.

■ 5. FUNCTIONS.—The functions of the Aircraft Warning Service are—

a. The organization and training of suitable military observation units, both permanent and mobile, and nonmilitary observation agencies; the installation, operation, and maintenance of observing equipment.

b. The provision of suitable signal communication systems for the transmission of information and orders; the prescription of proper forms of messages and a procedure for trans-

mitting them; the installation, operation, and maintenance of the signal communication system, except such parts of the communication system as may be prescribed elsewhere in this manual, and those covered by other directives and circulars.

c. The provision of suitable information centers for the collection and exhibition of information in the form desired by the interceptor commander, and the operation and maintenance of such centers.

d. The coordination of the Aircraft Warning Service with other communication and intelligence services of the Army, Navy, and other Government agencies and commercial companies.

e. Assistance to establish agencies in the development of equipment and supplies required for the Aircraft Warning Service.

■ 6. RESPONSIBILITY.—*a.* Air defense in time of war is the responsibility of the air defense commander. In the present emergency, defense commands have been organized with air forces as an integral part of each. The interceptor command of the air force is charged with the defense of the air space over the defense command. For a more complete picture of organization, see figure 1. For aircraft warning activities, the interceptor command is the basic organization. The headquarters of interceptor commands are so organized and trained as to be able to function as the headquarters of a defensive aviation task force in any theater of operation.

b. The commanding general of each air force is responsible for the organization and training of the headquarters of a fixed air force echelon, this fixed echelon to remain in the air force headquarters at all times. Through the headquarters for the fixed echelon, the commander exercises command and control over air bases and other fixed air force installations in his area. In the absence of the mobile forces, the fixed echelon of the air force commands and controls the fixed Aircraft Warning Service.

c. An interceptor commander is charged with the responsibility for the air defense of an area that has been normally divided into air defense regions. He decentralizes tactical control of pursuit units and Aircraft Warning Serv-

ice units to regional commanders. The interceptor commander is responsible for the disposition of the active defense forces throughout the entire area, for the designation

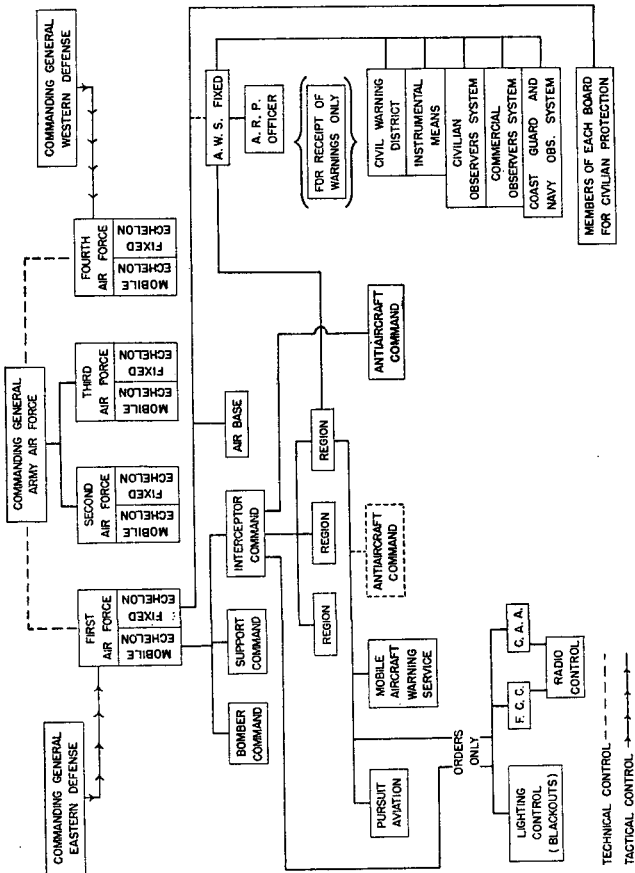

FIGURE 1.—Aircraft Warning Service in Army organization.

of region boundaries, and for the tactical reinforcement of one region by interceptor pursuit forces from another region when the situation necessitates.

d. Nonmilitary agencies for passive defense organization

are not the responsibility of regional commanders. For the purpose of setting up and operating fixed Aircraft Warning Service in the United States, civilian volunteers will be used in large numbers. A regional signal officer, with an appropriate Signal Corps detachment or unit, will be set up in each region in the United States. A general guide for the procurement and organization of nonmilitary personnel on a voluntary basis with reference to the law, opinion, and War Department policy is enunciated in AR 5-100 and 620-10.

e. Organization for, or conduct of, a general air defense which includes the proper organization of an Aircraft Warning Service is the responsibility of the interceptor command. The interceptor commander is charged with the air defense of an area, and is responsible for such coordination with passive defense agencies as will result in the establishment of sound policies for the elimination of direct aids to the enemy. The interceptor commanders and their designated agencies have sole responsibility for initiating orders for blackouts, radio silence, and the discontinuance of any activity which may assist an enemy in navigating to his objective.

f. The organization, training, and operation of the civilian air raid warning system within the continental United States is handled through the Office of Civilian Defense, which in turn develops, under the guidance of the commanding general of the defense command, the organization, training, and operation methods employed by the various agencies. The Signal Corps provides trained cadres to be employed at fixed filter and information centers manned by civilian personnel, provided by the Office of the Civilian Defense.

■ **7. MILITARY OBSERVERS.**—Military observer personnel of all arms and services must at all times work together to the fullest extent, and become personally acquainted with the problems, conditions, and operation of neighboring units. If the Aircraft Warning Service is to function efficiently, each unit and the military personnel within each unit must be responsible for a definite phase of information concerning hostile plane flights, and this information must be transmitted clearly, accurately, speedily, and in a prescribed form.

CHAPTER 2

ORGANIZATION

	Paragraphs
SECTION I. General	8
II. Factors affecting organization.....	9
III. Military units.....	10-27
IV. Nonmilitary agencies.....	28-29

SECTION I

GENERAL

■ 8. DEFINITIONS.—The following terms used in this chapter are peculiar to the organization of military units and non-military agencies. The terms are defined in the sense in which they are used herein.

a. Radar is a term used to designate radio sets SCR-268, SCR-270, and similar equipment.

b. Filter centers receive, plot, and filter reports of hostile and friendly aircraft, and immediately transmit the filtered information to information centers. In some cases, filter centers are control centers for active defense troops, and distributing centers for warnings to district warning centers in their filter areas.

c. Observation post, visual and aural, is a point properly located and equipped with a telephone, to which are assigned two or more observers.

SECTION II

FACTORS AFFECTING ORGANIZATION

■ 9. FACTORS AFFECTING ORGANIZATION.—*a.* The factors affecting organization of the Aircraft Warning Service employed within a certain area will depend upon the extent and importance of the area to be defended, the number of critical areas contained therein, and the method of defense to be employed.

b. The Aircraft Warning Service is an integral part of an interceptor command. In addition to the Aircraft Warning Service, the air defense command will include such of the

following components as may be necessary: interceptor pursuit aviation, antiaircraft artillery, and civil defense organizations. In general, the Aircraft Warning Service is organized as follows:

(1) Observation stations from which observers report the number, type, height, and direction of flight of all aircraft seen or heard.

(2) Radar stations which are operated by Signal Corps units for the purpose of supplying accurate information of the position of both friendly and enemy planes. The radar is tactically controlled by the interceptor commander or his representative through the radar office. The supply and installation of signal and reporting equipment and the training of related personnel are the responsibility of the unit signal officer.

(3) Filter centers to which all reports of observers are transmitted and there plotted and filtered.

(4) An information center to which the filtered reports from the filter centers are transmitted, plotted, evaluated, and the necessary action taken.

(5) A communication system consisting of telephone, tele-typewriter, radio, or any other means of signal communication tying these various agencies together, and allowing free and rapid intercommunication.

c. No one system of Aircraft Warning Service is applicable to all areas under all conditions. For example, the fixed air defense system in the United States can be more elaborate than the system used in an oversea theater of operations.

d. For a complete picture of the functions of an air defense command, the following applies: A given area is set up as an air defense area; this area will be under the command of the commanding general, interceptor command; all agencies utilized in this air defense are directly under the tactical control of the interceptor commander. The interceptor commander may divide the area into regions. The Aircraft Warning Service of the two or more regions is so organized as to be mutually exclusive, each to collect aircraft operational information for the information center of the region it covers. Each regional commander is made responsible for the air defense of his region. The available interceptor pursuit forces are allocated to the several regions, and come directly under

the tactical control of regional commanders (who are represented by regional control officers). Regional control officers, acting for regional commanders, will alert and release pursuit units, commit pursuit forces to interceptions, and supervise the exercise of ground control during interceptions. The regional commander controls the tactical operation and employment of the aircraft artillery units in his region to insure coordination, and to permit the most effective defense of the region. The Aircraft Warning Service keeps the regional controller continuously informed as to the number, type, and track of aircraft reported flying in his region.

e. The Aircraft Warning Service must function efficiently since the proportion of successful interceptions increases as the time consumed in reporting, filtering, plotting, calculating, and issuing orders decreases. Radar tracking devices serve to decrease this time and will therefore increase the proportion of successful interceptions.

f. In view of the fact that developments during a hostile air attack might necessitate the interceptor commander reinforcing certain regions with interceptor pursuit aircraft from other regions, it is essential that he be kept continually informed of the situation throughout his entire air defense area. In order to do this, it is necessary that an operations board be established at the command post of the interceptor command on which the general situation throughout the entire air defense area is depicted. This command post should be centrally located with respect to the area requiring air defense, and with respect to the "center of gravity" of enemy operations. Communications are provided for the transmission of information from the several regions to the operations board at the interceptor command headquarters, and for the issuance of necessary orders and instructions by the interceptor command to the several region commanders.

SECTION III

MILITARY UNITS

■ 10. GENERAL.—*a.* For aircraft warning activities, the interceptor command is the basic organization. Supervision of the training of Signal Corps troops with the Army Air Forces involves two separate types of work. The first is the Aircraft

Warning Service units, and second, the troops engaged in supplying administrative communication and maintenance to Signal Corps communication equipment.

b: Aircraft Warning Service troops are divided fundamentally into two types of units, fixed units and mobile units. The fixed units are known as frontier units, for example, signal reporting company, frontier, and signal plotting company, frontier. These units operate fixed communication apparatus in previously prepared positions, including information and filter centers organized throughout the United States with the aid of civilian groups. It is contemplated that these units will never leave the location to which they are originally assigned. During peacetime, and as long in wartime as is practicable, the fixed installation is augmented by the facilities available to the mobile units. Whenever the mobile unit is operating with an aircraft unit, the senior Air Corps (pilot) officer commanding the interceptor pursuit unit is in charge of aircraft warning activity in that area. The regional signal officer is subordinate to the interceptor unit commander whenever the interceptor unit commander is in the region. When however, there are no interceptor command units in the area, the regional signal officer is in charge of all the fixed installations. His area of responsibility, the region, is served by an information center that is manned by a signal plotting company, aircraft warning, frontier. The signal plotting company merely provides the cadre of instructors necessary to complete the training of civilians who do the actual plotting and other work at the information centers. The plotting company also furnishes the instructor groups for each of the filter centers established in the region.

c. In addition to the civilian observation system which functions through commercial telephone communications, the signal reporting company, aircraft warning, frontier, provides radar reports. The SCR-270's, semipermanently installed in previously prepared positions, provide long range military reporting in the region. The anti-aircraft SCR-268's will be used in an emergency to furnish radar reports, similar to the SCR-270's. The radar reports from anti-aircraft units to information center can be utilized in the process of observation.

d. One signal aircraft warning regiment, and, when necessary, one signal aircraft warning battalion, separate, are generally assigned with each interceptor pursuit group in an interceptor command. This assignment is based on air allotment of one group of interceptor pursuit aviation to each air defense region. It provides for the establishment of a number of air defense regions for aircraft warning defense in each interceptor command. With the assignment of each additional group of pursuit aviation to the interceptor command, there should be a corresponding assignment of aircraft warning regiments.

■ 11. MILITARY UNITS.—The Signal Corps units assigned to the Aircraft Warning Service are of 16 types, so organized as to perform aircraft warning tasks required for passive or active defense. The charts, figures 2 to 10, inclusive, are to be used only as guides.

■ 12. SIGNAL AIRCRAFT WARNING REGIMENT.—The signal aircraft warning regiment (T/O 11-411) consists of a headquarters and headquarters company (T/O 11-412), a plotting battalion (T/O 11-415), a reporting battalion (T/O 11-425), and a medical detachment (T/O 11-411). (See fig. 2.) The aircraft warning regiment has three long-range and seven short-range radar units. These are divided into one long-range and two short-range units per company of the reporting battalion. The headquarters and headquarters company of the reporting battalion has the seventh short-range unit. Operation is fundamentally based on the so-called close-in (CI) reporting platoon, which operates one short-range unit, and the distant reporting (DS) platoon, which operates one long-range unit. Each reporting platoon is equipped with radio equipment for submitting its reports to the mobile information centers operated by the plotting company of the plotting battalion. The communication company of the plotting battalion operates and maintains the communication systems of the regiment. When construction of long wire lines is necessary, a signal construction battalion will be utilized. The signal aircraft warning regiment is both a tactical and administrative unit and as such is an independent organization.

■ 13. SIGNAL HEADQUARTERS AND HEADQUARTERS COMPANY, AIRCRAFT WARNING REGIMENT.—The signal headquarters and head-

quarters company, aircraft warning regiment (T/O 11-412), consists of a regimental headquarters, a company headquarters, a headquarters company (consisting of regimental headquarters platoon and supply platoon), and a maintenance platoon. (See fig. 2.) This unit is staffed with officer personnel for coordination and controlling operation of distant and close-in reporting platoons under supervision of the controller at the information center. The maintenance platoon is charged with the repair and operation of the motor vehicles.

■ 14. SIGNAL PLOTTING BATTALION, AIRCRAFT WARNING REGIMENT.—The signal plotting battalion, aircraft warning regiment (T/O 11-415), consists of a signal headquarters and headquarters company (T/O 11-416), a signal plotting company (T/O 11-417), and a signal communication company (T/O 11-418). (See fig. 2.) This unit has the responsibility of plotting information as transmitted by the reporting agencies according to the methods set forth by the air force commander. For communication company duties see paragraph 12.

■ 15. SIGNAL HEADQUARTERS AND HEADQUARTERS COMPANY, PLOTTING BATTALION, AIRCRAFT WARNING REGIMENT.—The signal headquarters and headquarters company, plotting battalion, aircraft warning regiment (T/O 11-416), consists of a battalion headquarters, company headquarters, battalion headquarters section, supply and headquarters section. (See fig. 2.) The duties of this unit consist of administration, supply, and coordination of Signal Corps activities of information center and filter centers.

■ 16. SIGNAL PLOTTING COMPANY, AIRCRAFT WARNING REGIMENT.—The signal plotting company, aircraft warning regiment (T/O 11-417), consists of a company headquarters section, supply and transportation section, operating board, radar board, and intercept board. (See fig. 3). The duties of this unit are to establish means of plotting information received from reporting agencies, evaluation of same, and the rapid relaying of this information to using agencies.

■ 17. SIGNAL COMMUNICATION COMPANY, AIRCRAFT WARNING REGIMENT.—The signal communication company, aircraft warning regiment (T/O 11-418), consists of headquarters

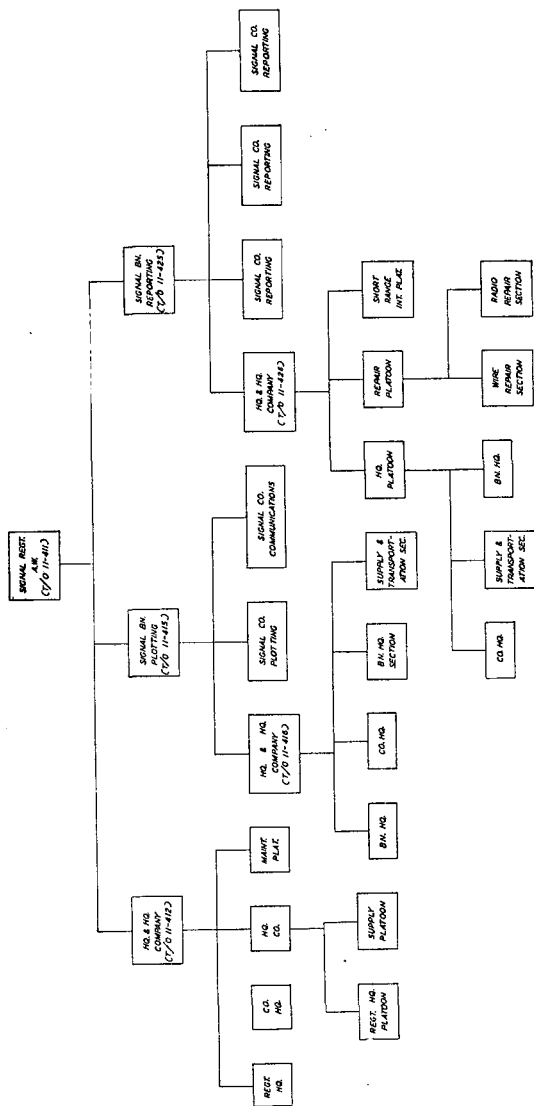

FIGURE 2.—Signal aircraft warning regiment.

platoon (consisting of an administration section and a motor and supply section), a wire platoon, a message center platoon, and a radio platoon. (See fig. 4.) This unit, although a component of the plotting battalion, installs, operates, and maintains communication systems of the aircraft warn-

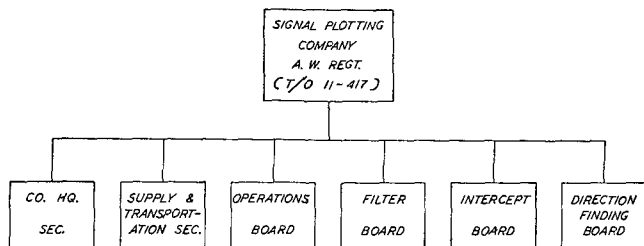

FIGURE 3.—Signal plotting company, aircraft warning regiment.

ing regiment within the limitations of its personnel and equipment.

■ 18. SIGNAL REPORTING BATTALION, AIRCRAFT WARNING REGIMENT.—The signal reporting battalion, aircraft warning regiment (T/O 11-425), consists of a headquarters and head-

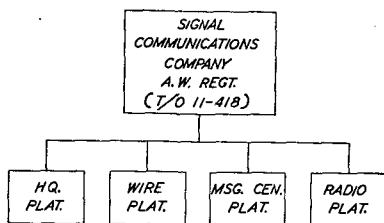

FIGURE 4.—Signal communications company, aircraft warning regiment.

quarters company (T/O 11-426) and three reporting companies (T/O 11-427). (See fig. 2.) For duties of reporting companies, see paragraph 20.

■ 19. SIGNAL HEADQUARTERS AND HEADQUARTERS COMPANY, REPORTING BATTALION, AIRCRAFT WARNING REGIMENT.—The signal headquarters and headquarters company, reporting bat-

talion, aircraft warning regiment (T/O 11-426), consists of a battalion headquarters, headquarters platoon (consisting of a company headquarters, a supply and transportation section, and a battalion headquarters section), a repair platoon (consisting of a wire repair section and a radio repair section), and a short range intelligence platoon. (See fig. 2.) The headquarters and headquarters company of the reporting battalion is so organized that it can provide for and administer to personnel who, in combat, are scattered over wide areas, and it also contains specialists trained for specific duties with the Aircraft Warning Service.

■ 20. SIGNAL REPORTING COMPANY, AIRCRAFT WARNING REGIMENT.—The signal reporting company, aircraft warning

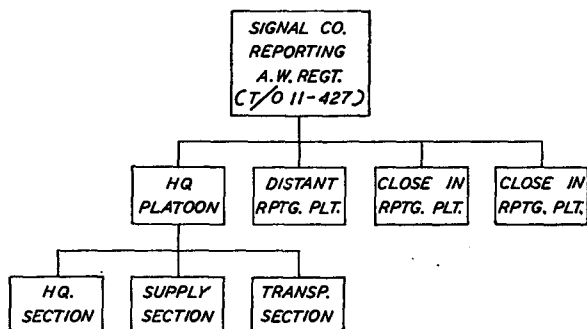

FIGURE 5.—Signal reporting company, aircraft warning regiment.

regiment (T/O 11-427), consists of a headquarters platoon (a headquarters section, a supply section and a transportation section), a distant reporting platoon, and two close-in reporting platoons. (See fig. 5.) The organization is arranged to permit platoons to carry on simultaneously aircraft warning activities over widely separated areas. Each platoon functions as a team.

■ 21. SIGNAL HEADQUARTERS AND HEADQUARTERS COMPANY, AIRCRAFT WARNING SERVICE, INTERCEPTOR COMMAND.—The signal headquarters and headquarters company, Aircraft Warning Service, interceptor command (T/O 11-450-1), consists of an interceptor signal officer section, an administration section,

a supply and transportation section, a message center section, a plotting section, a radio section, and a telephone and telegraph section. (See fig. 6.) This unit is so organized as to control all Aircraft Warning Service facilities in an area under control of the commanding general of the interceptor command. This company also provides message center personnel and men for the operation of the commanding general's "operation board." This board includes the territory of all the regions under the control of interceptor commander and overlaps into the adjacent air defense area.

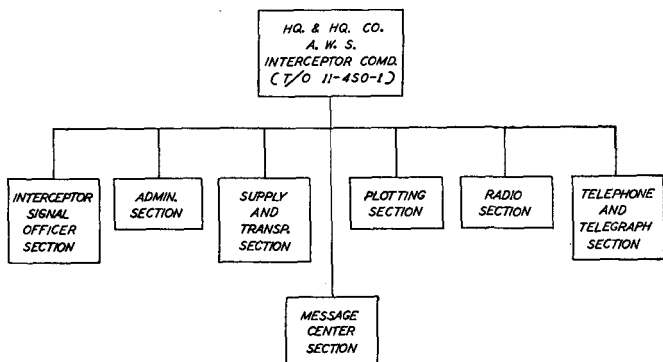

FIGURE 6.—Headquarters and headquarters company, aircraft warning, interceptor command.

■ 22. SIGNAL AIRCRAFT WARNING BATTALION, SEPARATE.—The signal aircraft warning battalion, separate (T/O 11-445), consists of a headquarters and headquarters company (T/O 11-446), a plotting company (T/O 11-447), two reporting companies (T/O 11-448), and a medical detachment. (See fig. 7.) The signal battalion, aircraft warning, separate, operates in the same manner as the signal aircraft warning regiment except that it has 14 distant reporting platoons divided into two companies. The functions of the plotting company and communication company are carried out by the plotting company of the aircraft warning battalion.

■ 23. SIGNAL HEADQUARTERS AND HEADQUARTERS COMPANY, AIRCRAFT WARNING BATTALION, SEPARATE.—The signal headquarters

and headquarters company, aircraft warning battalion (T/O 11-446), consists of a battalion headquarters, a company headquarters, a battalion headquarters section, a supply and transportation section, and a repair section. (See fig. 8.) This unit is organized so as to coordinate signal activities in the information center. Trained specialists of this unit are required for second echelon repair of Signal Corps equipment.

■ 24. SIGNAL PLOTTING COMPANY, AIRCRAFT WARNING BATTALION, SEPARATE.—The signal plotting company, aircraft warning battalion (T/O 11-447), consists of a headquarters platoon (consisting of a company headquarters section and a supply and transportation section), a plotting platoon, and a communication platoon consisting of a radio section and a wire section. (See fig. 7.) This unit is organized so as to carry out activities relative to the plotting and display of information received from reporting agencies in connection with the Aircraft Warning Service.

■ 25. SIGNAL REPORTING COMPANY, AIRCRAFT WARNING BATTALION, SEPARATE.—The signal reporting company, aircraft warning battalion, separate (T/O 11-448), consists of a headquarters platoon (consisting of a company headquarters and a supply and transportation section), and seven distant reporting platoons. (See fig. 7.) This unit is so organized that the platoons can function as a team over a wide area for the purpose of reporting information as desired by the air defense commander.

■ 26. SIGNAL PLOTTING COMPANY, AIRCRAFT WARNING FRONTIER.—The signal plotting company, aircraft warning, frontier (T/O 11-467), consists of a regional signal officers section, a company headquarters, an administration platoon, a supply platoon, a filter platoon, an information center platoon, a ground observation platoon, and a medical detachment. (See fig. 9.) This unit is organized so as to carry out aircraft warning activities of a region consisting of three filter centers and an information center with personnel available for three reliefs. The ground observers platoon refers to military personnel only, and is not concerned with the civilian observers organized by local government. The medical detachment personnel of this unit will also care for the needs of the reporting companies, aircraft warning, frontier.

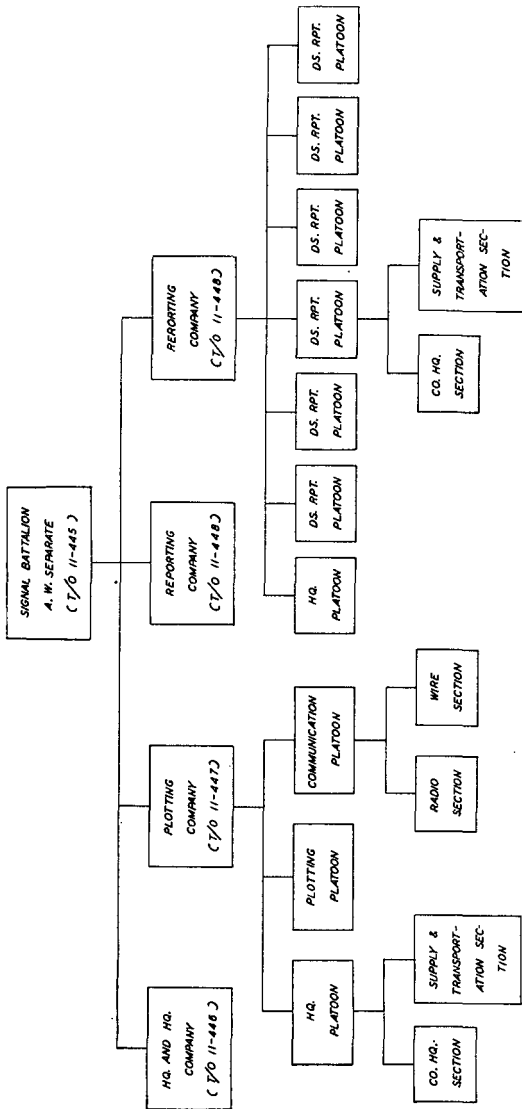

FIGURE 7.—Signal aircraft warning battalion, separate, including signal plotting company, aircraft warning battalion, separate; and signal reporting company, aircraft warning battalion, separate.

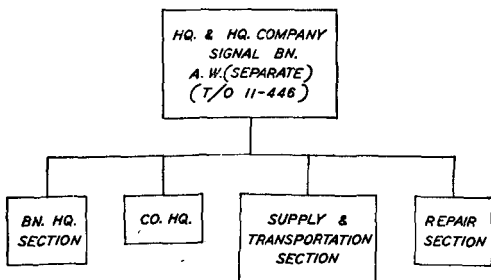

FIGURE 8.—Signal headquarters and headquarters company, aircraft warning battalion, separate.

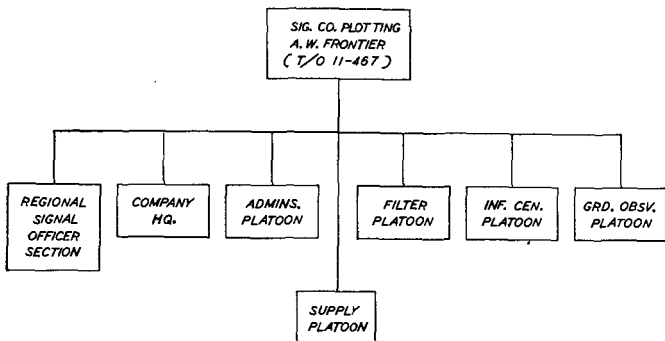

FIGURE 9.—Signal plotting company, aircraft warning, frontier.

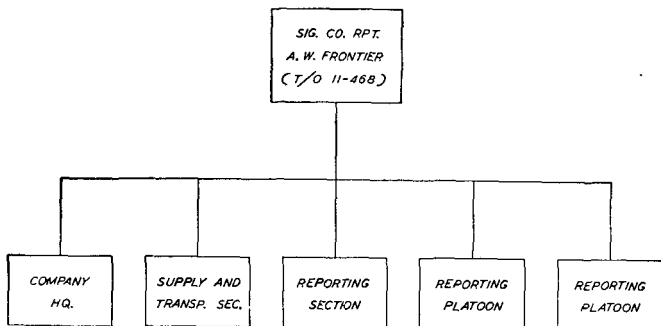

FIGURE 10.—Signal reporting company, aircraft warning, frontier.

■ 27. SIGNAL REPORTING COMPANY, AIRCRAFT WARNING, FRONTIER.—The signal reporting company, aircraft warning, frontier (T/O 11-468), consists of a company headquarters, a supply and transportation section, and three reporting platoons (see fig. 10). This unit is organized to furnish complete teams for reporting aircraft activities in connection with the Aircraft Warning Service.

SECTION IV

NONMILITARY AGENCIES

■ 28. GENERAL.—*a.* The United States has been divided into air defense areas, and these defense areas are further divided into warning districts. The warning district is a unit of civilian air raid warning systems, and a message transmitted to any warning district will always apply to the whole of the district, and that district alone. It is highly important that a message for one warning district should not become known to persons in another district. Messages of warning will be dispatched from the point of origin to the various warning districts one at a time, as each district becomes threatened by the progress of a raid.

b. In order to have the information centers and filter centers function efficiently, nonmilitary personnel will be trained in the operation of telephones, telephone switchboards, teletypewriters, indicating devices, and the various apparatus and equipment used at filter centers and information centers; that is, filter boards, operation boards, intercept boards, radar boards, etc.

c. Personnel for nonmilitary positions will be obtained by volunteers from various organizations, such as fraternal, civic, and service clubs until the formation of a Women Auxiliary Army Corps makes paid, uniformed female personnel available. Not only from the viewpoint of conservation of man power, but for efficiency, the employment of women in filter and information centers is indicated. Military personnel should be limited to essential instructors, supervisors, and other key personnel.

■ 29. TRAINING NONTECHNICAL PERSONNEL.—*a.* Personnel of information and filter centers will receive instructions in plotting and telling as a group. A complete descriptive picture

of the basic operations of these centers will be a valuable aid to the individual. During this preliminary part of their instruction, the information and filter center personnel should learn to work together as a team. No attempt will be made at first to instruct them in the details of the duties of other personnel of the centers, although such a knowledge is highly desirable to allow for temporary replacements and in order that they can provide assistance to one another in rush periods. Any changing of duties should be deferred until each member has become so expert in his own duties that efficient team work is almost automatic. Collective training must consist of a progressive series of exercises which should eventually include all operations in all the various Aircraft Warning Services which together make up the complete information and filter center. It is important that training of the personnel of a center take place in the established information center or filter center. Collective training exercises should rarely last more than an hour, and should be followed by a conference at which the personnel taking part may have their attention drawn to mistakes.

b. During the first phase of training, suitable messages to afford practice to the control room staff should be prepared beforehand, exactly in the form in which they would be delivered from the ground observers, and telephoned to the control room at intervals of time controlled by the officer in charge of instruction. At the outset, a single message should be dealt with step by step, ample time being allowed for full explanation of procedure. Gradually, the situation revealed by the messages should be made increasingly complicated and difficult to deal with, and the rate at which messages are received should be increased. It should, however, be remembered that under actual operations, the message handling capacity will limit the number of messages received from observers. Results which are both discouraging and false may result if excessive hurrying of the trainee is required during practice. Remember that accurate plotting, filtering, and telling require the use of trained minds rather than the mechanical use of trained hands.

c. Nonmilitary agencies should be exploited to provide civilian personnel for ground observers. Observers are the personnel reporting movement of aircraft to the information

or filter centers. The observer's place in the Aircraft Warning Service is one of exacting service, requiring definitely known abilities and qualifications. The observer will be instructed to observe certain facts regarding aircraft, record these facts, and report them immediately by telephone. The great speed and wide radius of action of aircraft require that the surveillance of the air by means of observation from the ground be continuous over extensive areas. Accuracy in aircraft identification can only be attained by a careful and thorough study of the characteristics of the different types of machines in all positions of flights. However, accuracy in identifying aircraft is not nearly so important to the observer as accuracy in judging altitude, distance, and direction, and speed and accuracy in transmitting the information.

CHAPTER 3

OBSERVATION SYSTEMS

Paragraphs

SECTION I. Mechanical.....	30-35
II. Nonmechanical.....	36-37
III. Messages and their transmission.....	38-41
IV. Installation of information and filter centers.....	42-48

SECTION I

MECHANICAL

AAAI
h. T
(1)

■ 30. GENERAL.—*a. Radar.*—This means of observation is the function of reporting platoons, both close and distant. Observation is made by means of complex electrical apparatus (radar) operated by highly trained specialists.

b. Duties.—(1) The radar officer is the representative of the controller and directs the radar units in tactical operation from the information center.

(2) The oscilloscope operator interprets the oscilloscope picture into useful target reports.

(3) The radar plotter at radar locations changes polar coordinates to grid coordinates for transmission to filter or information center.

(4) The plotter at the information center with suitable plotting equipment sets up the information on the radar board showing time, course, number of planes, etc.

(5) The teller at the information center relays information from the radar board to the intercept officer or other interested agency at the information center.

(2)

■ 31. FUNCTION.—*a.* The effective function of the radar unit remains unimpaired even though the aircraft may be hidden by smoke, haze, clouds, darkness, or is out of range of the human eye. For the most part, the elements do not reduce the effectiveness of radar observation. It is designed to search for distant aerial targets and, in addition, it supplies a continuous flow of data which locate aircraft accurately with a base reference at the detecting unit.

b. In many cases, radar efficiency is governed by terrain features. In selecting a suitable site as a preliminary step, all available maps should be consulted for natural formations so that any terrain feature, such as a mountain, which would mask the beam, can be avoided. The final selection of a site must, of course, be made from physical reconnaissance, not from a map. The final decision on suitability can only be made with a radar installed at the site.

c. The data obtained by radar are transmitted through the system of signal communication to the information center, where the regional commander or his representative (controller) can observe the course of hostile aircraft tracked by the equipment, estimate the situation, and issue such orders as are deemed necessary to intercept such targets.

d. The radar equipment, both mobile and fixed, will be employed in a theater of operation as directed by the interceptor commander. Tactical direction of the radar is the responsibility of the interceptor commander or his representative through the radar officer.

e. Tracking of targets at certain azimuths can be quickly obtained if the radar plotters have had sufficient training "on location." Minimum and maximum distances are controlled through many factors, and a thorough knowledge of equipment on location is valuable for efficiency of operation. Training on location should be expedited, and all operators should be given periods of training on the oscilloscope so that they can quickly become familiar with operation on location.

f. Sectional aeronautical charts (1:500,000) should be used for plotting because location of targets can be no more accurate than the map.

g. Coordinates of target positions will be transmitted to information centers in the rectangular coordinates of the air defense grid system. (See par. 68.) Controllers will inform radar officers of the general areas it is desired to cover. The radar stations will be prepared to carry out all orders issued to them by the regional radar officer. Radar will be used for search and track or both. The normal limits of search for each radar in the region will be prescribed in both azimuth and range by the region radar officer. In the absence of specific instructions, the radar will always search over its normal search area.

■ 32. MOBILE RADAR INSTALLATION.—*a. Major components.*—The major components of this unit consist of four vehicles:

(1) *Power supply truck K-31.*—This truck contains a four-cylinder gasoline engine which drives a 120/208-volt, 60-cycle, three-phase a-c generator, separately excited by a d-c generator; and a central power panel containing the necessary measuring instruments, voltage regulator, overload relays, and a high-voltage rectifier for transmitter plate power.

(2) *Operating truck K-30.*—This truck contains a high-power radio transmitter, a cooling system for the transmitter tubes, two cathode-ray oscilloscopes (one carried as a spare), two superheterodyne receivers (one spare), a vacuum-tube keyer, a plotting table, and containers for spare parts and tubes.

(3) *Antenna mount (trailer) K-22-B.*—This unit is transported by a prime mover which can be readily coupled or uncoupled as desired. On the trailer are mounted the main antenna support or tower, on which the antenna proper is mounted, the azimuth motors which control the direction and speed of rotation of the antenna, a power winch for erection of the antenna tower, and, in addition, a compartment containing all the necessary tools and equipment required to assemble the antenna ready for operation. The prime mover has no function in the operation of the equipment after the antenna mount has been placed on location and the jacks have been placed.

(4) *Stake body truck K-33.*—This truck is used to transport the antenna proper, together with certain other pieces of equipment required for the assembly, installation, and operation of the equipment. Other than for transportation purposes, the K-33 truck is not required for the operation of the radar.

b. Additional transportation.—In addition to the equipment mentioned in *a* above, there are six vehicles provided for the additional transportation requirements for personnel and equipment. These are not directly involved in the operation of the radar.

■ 33. LOCATION AND UNIT ARRANGEMENT.—*a.* Due to the characteristics of radar, it is preferable that the location selected for operation be free from buildings, trees, power lines, and

other obstructions extending above the base of the antenna in the area coverage of the equipment.

b. Ideal location of radar equipment presents a problem which can best be solved by trial method. A hilltop is not necessarily the best location. The preferred location is one in which the reporting sector is 180° , and in which the antenna can be placed in front of trees, thus providing a background which reduces to a large extent the possibility of observation, since the antenna and the antenna tower is a frame presenting no large solid surface. The natural cover provided by the trees makes an exceptionally good location. The situation and directives from higher authority will govern to a certain extent the location, but the mission must be com-

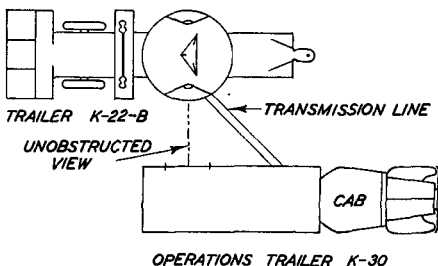

FIGURE 11.—Location of trailers.

pleted even if the equipment has to be located in an exposed area. The actual arrangement of the antenna mount, the operating truck, and the power truck should conform to that shown in figure 11, as closely as the individual location will permit.

c. When a reporting platoon moves into position, the platoon commander will select the actual site for the antenna mount first, keeping in mind the fact that the operating truck will have to be located so as to permit the plotter, teller, and the oscilloscope operator to have an unobstructed view of the azimuth indicator. The transmission line coupling and the operating truck to the antenna mount must be in a straight line.

d. The power supply truck may be placed in any convenient location within the limits of the power cables; however, con-

sideration must be given to the operation and maintenance of equipment. Sufficient space should be allowed between the truck units so that personnel can move about freely.

■ 34. REPORTING PLATOON.—*a. Organization.*—T/O 11-427 will be used as a guide for personnel assignments within the platoon.

b. Operating detail and power-plant detail.—The reporting platoon consists mainly of the operating detail and the power-plant detail. The personnel of these two details are responsible for the actual installation, operation, and maintenance of the radar equipment. The operating detail consists of the aircraft warning communication operators, the radio receiver attendants, and the radio transmitter attendants. The operating detail installs, operates, and maintains the equipment contained in the operating truck K-30 and the antenna mount K-22-B. The power plant and rectifier detail provides the necessary personnel required to set up, operate, and maintain the gasoline engine, the a-c generators, and the rectifier, all of which are contained in the power supply truck K-31.

c. Radio detail.—This consists of a sergeant, chief radio operator, and four privates (radio operators). This detail, under the supervision of the sergeant, installs, operates, and maintains the radio equipment and other communication equipment used by the platoon. However, the communication personnel of a distant reporting platoon is not responsible for the wire communication to higher headquarters, nor to filter or information centers.

d. Guard detail.—Twenty-four-hour guard will be maintained on all radar equipment.

e. Transportation detail.—This consists of one sergeant, truck master; one private, automobile mechanic; and six privates, chauffeurs. This detail under the sergeant truck master is responsible for maintenance of all vehicles of the platoon, and provides six chauffeurs for the vehicles.

(1) Chauffeurs for the stake-body truck K-33, prime mover K-32, power truck K-31, and operating truck K-30 will be provided by the personnel of the operating and power-truck details. The prime mover K-32 should be driven by the most experienced corporal or private available in these two details, and he should be assigned to the operating detail. This will

place this chauffeur-technician in a position in which he is near the prime mover.

(2) The same practice should be followed in the selection of the driver for the power truck K-31, but he should be one of the power plant and rectifier attendants. The driver of the operating truck K-30 and the stake-body truck K-33 should be either an aircraft warning operator, a radio-receiver attendant, or a radio-transmitter attendant. Chauffeur and driver must each obtain a Government driver's permit (see FM 25-10) prior to actual operation of a Government-owned vehicle.

(3) Personnel arranged to ride with the chauffeur-technician will be trained in driving, and will have received a Government permit.

f. Supply detail.—This detail consists of one sergeant who is the platoon supply sergeant, and one private who is the platoon supply clerk. This detail is responsible for the procurement, storage, and issue of all platoon supplies, under the direct supervision of the platoon commander.

g. Mess detail.—The two cooks and one cook's helper install, operate, and maintain the platoon mess, under the direct supervision of the junior commissioned officer present who, in addition to his other duties, will be the platoon mess officer.

■ 35. INSTALLATION.—*a.* After the location of the reporting platoon has been selected, each vehicle will be moved to the exact location. No sequence of this movement is given except that the antenna mount, the operating truck, the power-supply truck, and the stake-body truck will be given priority, in the order given, over all other vehicles in the platoon.

b. The actual installation of the radar equipment will be accomplished by the operating detail and the power-plant and rectifier detail (see TM 11-1100). The operating detail will be divided into two units for the initial installation: one unit consisting of two privates, radio-receiver attendants, and the other unit consisting of the balance of the personnel of the operating detail. The power-plant detail will remain as a unit, and their work will consist of making all the electrical connections between the power-supply truck, the operating truck, and the antenna mount, and placing the equipment in the power-supply truck in operation. A four-

man unit, consisting of two receiver attendants and two transmitter attendants from the operating detail, will set up the equipment in the operation truck, and the balance of the operating detail will work on the assembly and the erection of the antenna.

c. The technical sergeant, aircraft warning chief, will be charged with the installation of the radar equipment, and, as such, will necessarily be a highly trained technical man. All maintenance will be under the supervision of the technical sergeant, or the staff sergeant of the platoon.

d. Since each unit of the system depends on both of the other units in its operation, installation will start on each unit as soon as the proper order has been given, and will continue until the installation is complete.

e. The power-supply truck detail will install the ground system between the power-supply truck and the operating truck; also, this detail will install the connecting cables between the power-supply truck and the operating truck, and cables between the operating truck and the antenna mount. When the ground system and connecting cables have been installed, the staff sergeant, assistant aircraft warning chief, will check the ground connections before the power plant is placed in operation.

f. The four men assigned to the operating truck will prepare the equipment in the operating truck for operation by installing the various tubes in their proper sockets, and then place the receiver and oscilloscope in their respective positions, and connect. They will then check the water in the cooling system and replenish if necessary, and afterward lay out the transmission line and the transmission-line supports.

g. The details assigned to the antenna mount will jack up the mount on support jacks, level the antenna base, unfold the antenna tower, and secure and assemble the antenna sections and tuning elements on the tower, and raise it into position.

h. With power-supply equipment in operation, and the equipment in the operating truck properly installed and connected, the technical sergeant, aircraft warning chief, will have complete charge of initial equipment adjustment as provided for in the instruction book covering the par-

ticular unit. This does not relieve the platoon commander of responsibility for the operation of the equipment. He, therefore, should keep informed as to the progress of the installation and adjustment of the equipment, and should be prepared to take such action as is necessary to insure its rapid installation and adjustment. He should make a final inspection when the installation is completed, and cause any necessary correction to be made. Throughout operation, he should make periodic inspections and corrections of adjustments.

i. The following records will be kept:

(1) The power-plant detail will maintain an accurate record of the operation of their equipment. This will include *all* information concerning the rectifier, generator, and gasoline engine; also, oil, gas, and water consumption.

(2) The operating detail will maintain records of the operation of the equipment. This will include *all* information concerning the cooling unit, transmitter, receiver, oscilloscopes, keyer antenna, and the tracking of targets.

SECTION II

NONMECHANICAL

■ 36. GENERAL.—*a. Nonmilitary agencies.*—Organization of nonmilitary agencies will be governed by AR 5-100 and AR 620-10. The civilian volunteer agencies will be guided by the policies instituted by the commanding general, interceptor command. The regional signal officer, with a suitably organized unit, will instruct and supervise the operations of civilian volunteer observation units which are organized in each region within the United States for passive defense.

b. Definitions.—(1) *Observer.*—A person whose duty it is to detect aircraft and report certain information with regard to such aircraft to the filter center.

(2) *Observation post.*—A point properly located and equipped with a telephone, to which are assigned two or more observers.

(3) *Flash message.*—A prearranged message of uniform continuity of text by which observers may transmit vital information concerning aircraft heard or seen without loss of time. (See Form No. 1, par. 1, appendix.)

■ 37. ORGANIZATION.—*a.* Preparation for effective air defense in war requires organization and training in peace. A territorial organization is created that may be expanded quickly in an emergency to meet the demands of war. The basic peacetime framework and training should include—

(1) A command agency, interceptor command.

(2) An Aircraft Warning Service with region cadres and information and filter centers with complete operating equipment, including interior wiring and wire connections to the commercial telephone system.

(3) A program of training to include as a minimum: periodic training of observers; periodic training of information and filter center details; continued training of pursuit officers in the mechanism of interception; periodic operation of air defense commands with their complete organization of command and control systems, aircraft warning services, interceptor pursuit aviation, aircraft representing an enemy, anti-aircraft artillery, barrage balloons, and air raid warning systems.

b. Nonmilitary agencies, other than observers, will be guided by two considerations—the necessity for eliminating direct aids to the enemy, and for air raid precautions.

c. Nonmilitary agencies will be organized through the cooperation of civilian defense agencies, based on the plan set up by the commanding general, intercept or command.

d. Observation systems, nonmechanical, are systems for the observation of aircraft by selected military personnel in designated areas, and by all nonmilitary personnel who have volunteered their services. Observers transmit, generally through a telephone communication system using commercial circuits and in the sequence and form prescribed by the interceptor command, certain information about aircraft seen or heard by them to information centers, through filter centers. The data thus obtained are plotted in a standard form, in order that the regional commander may estimate the situation, and issue such orders and instructions as are deemed necessary, including air raid warnings through the appropriate agencies.

e. The organization of an effective observer system for the Aircraft Warning Service requires a great deal of time. Observers should be told as much of the fundamentals of the Aircraft Warning Service as is not confidential. They should

be made to understand the vital necessity for their services and for speed and accuracy in reporting. Their morale and interest should be stimulated from time to time by personal contact with representatives of the interceptor command. Instruction of observers entirely by correspondence is unsatisfactory. It should be remembered that observers are volunteers not operating under close and continual military supervision. If their interest is allowed to lag, their value will decrease proportionately.

f. In actual operation, the observation post will be manned 24 hours a day. Therefore, sufficient volunteers must be designated for each post to provide a suitable number of substitute observers ready to take the place of any regular observer who through illness or for other reasons is unable to fulfill his assignment. A schedule of service hours must be worked out to fit the periods of availability of these volunteers. Some 12 to 16 observers will generally be required for each observation post.

g. Volunteer observers will be stationed at appropriate locations, both in and out of cities, and are to be trained in observing and reporting to a filter center. This filter center filters out all nonessential information reported by observers, and transmits the filtered information to an information center.

h. Both men and women will be used as observers. Men observers should be beyond selective service age or unfit for combat duty. Observers should be trustworthy citizens selected without regard to race, creed, or color, with the time, ability, and physical capacity to carry out their assignments faithfully at observation posts. Volunteers must be alert, careful, and dependable in character. They must have the diligence to study and learn to recognize, locate, and report the numerical strength, altitude, and type of aircraft spotted, direction of their movement, and time of observation.

i. The observation of aircraft consists in reporting speedily by commercial telephone to a filter center the presence of aircraft seen or heard from an observation post, their number, type, altitude, approximate location, and the direction in which they were headed. It is the observer's responsibility to get this message to filter center plotters speedily, so that in the event the observed flight is identified as an enemy target,

steps may be taken to intercept the hostile aircraft and prevent them from completing their mission.

j. The following material will be furnished civilian observation post organizers. (See appendix for sample forms.)

(1) One small section of map showing the general location of the observation post to be established (fig. 12).

(2) Five copies of Form No. 2 (Report of Observation Post Organizers).

(3) Five copies of Form No. 3 (Instructions for Chief Observers).

(4) Three copies of Form No. 4 (Report of Chief Observers).

(5) War Department penalty envelopes.

(6) Twenty copies of Form No. 5 (Instructions for Observers).

(7) Two orientation cards (fig. 20, appendix).

k. In organizing civilian observation posts, the following definite and systematic procedure is indicated:

(1) The organizer will be furnished with a map showing the approximate desired location of the observation post (see circle within map, fig. 12). It is known from information furnished by the telephone company that there is at least one telephone subscribed in the circled area. The observation post should be located in a quiet place favorable to observation in all directions and within 15 seconds' walk from a telephone.

(2) The organizer should investigate the area personally, select the best place for observation and telephone service and secure the voluntary use of the premises and telephone for the observation post.

(3) It is desired that where possible a direct or individual line telephone be used. If it is impracticable to obtain an individual line telephone, then a party line may be used.

(4) The observation post should be so located that observers can reach the telephone within 15 seconds after the observation of airplanes.

(5) The telephone and premises must be available for immediate access for day and night service.

(6) All telephone calls made on the telephone selected pertaining to the operation of the aircraft warning service in the form of flash messages are charged to and paid for by the Government.

(7) If the organizer is unable to secure the volunteer use of a private telephone and premises, he should see if there is a nearby organization such as a lodge, fraternal order, businessman's club, women's club, or municipal agency which might provide a telephone or an extension to one that may be used.

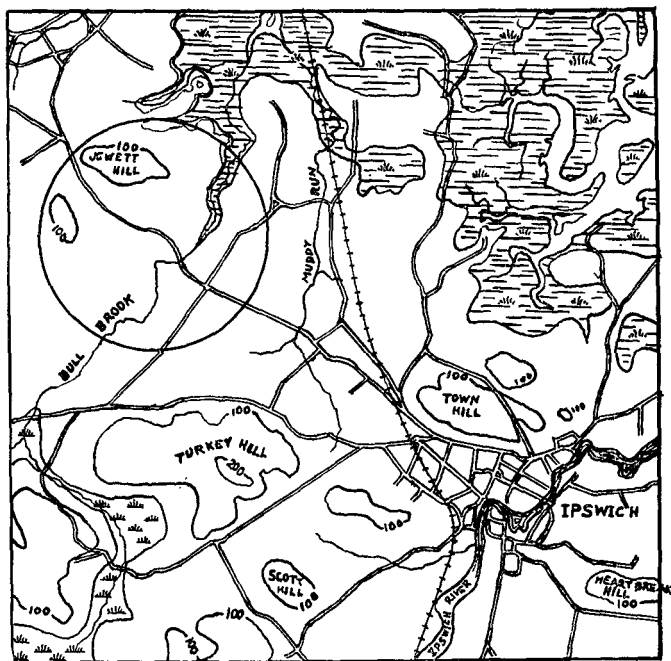

FIGURE 12.—Map for observation post location.

(8) When he has established the location of the observation post the organizer should place a small cross on the map at the exact location of the observation post within the circle. This map should be mailed with two completed copies of Form No. 2, with the telephone number, name, and address of the subscriber, to the regional signal officer. This telephone will be the only one used by the observers of this

post for reporting planes. Copies of Form No. 2 can be obtained from the regional signal officer.

(9) A chief observer should be selected who will agree to organize a sufficient number of observers to maintain a continuous day and night watch with two observers on duty at all times.

(10) With the aid of the chief observer, the organizer should select two or three assistant chief observers to act in the absence of the chief observer and supervise the watches when active operations are being conducted.

(11) The organizer should execute all five copies of Form No. 2 and mail two completed copies, with the map on which the location of the observation post is marked, to the regional signal officer. The remaining three copies of Form No. 2 will be disposed of as follows:

1 copy for the files of the State defense council.

1 copy for the files of the observation post organizer.

1 copy for the files of the chief observer.

(12) Form No. 3 will be distributed as follows:

1 copy for the observation post organizer.

1 copy for the chief observer.

3 copies for the assistant chief observers.

(13) The confidential code name of each observation post will be sent to the organizer after the observation post has been organized and his report received by the headquarters of origin of forms.

SECTION III

MESSAGES AND THEIR TRANSMISSION

(1) ■ 38. FLASH MESSAGE.—*a.* In order to save every possible second, to reduce the time lag in the reporting of aircraft to the filter center, and to insure that the essential information is transmitted in the most concise and expedient manner, the flash type of message is used. (See par. 124, FM 11-5.) It is important that every observer practice the preparation and telephoning of flash message with absolute minimum loss of time after the airplanes have been observed. (See Form No. 1, appendix.)

b. The information contained in the body of the flash message must be transmitted in sequence of the numbered

vertical columns. Each column must be checked or filled in to correspond with the information the observer has obtained. All of the information must be transmitted in accordance with a definite procedure.

c. The observation post is shown on a map at the filter center, and when a report is received the filter center knows that aircraft were seen or heard near the observation post reporting. As other observation posts report in succession, it is possible to determine that speed and course and to confirm information previously received about the observed aircraft. Very accurate information as to the location of aircraft is needed to permit accurate tracking. It is necessary that the observer report the direction and distance of the airplanes with reference to the observation post when observed.

Column 6 of Form No. 1 gives the direction, and column 7 gives the distance. When the airplanes are directly over the observation post, the report will be "Overhead."

d. The following detailed information relates to the flash message (Form No. 1).

Column 1. In this column the observer either underlines the appropriate word or gives the exact number, depending upon his observation. He must not delay the report to get the exact number. He should try to count the airplanes, but if they cannot be counted quickly he should give his best estimate.

Column 2. It is very difficult to identify airplanes. One of the easiest identifiable characteristics is the number of motors. If the airplanes are *seen*, the observer should use one of the three designations in the column. If the number of motors cannot be observed, he should report all small airplanes as single motor and all large ones as multimotor.

Column 3. The observer underlines the appropriate word corresponding to his observation. "Very high" and "Very low" are extremes. When the airplanes are so high they are barely visible or cannot be seen he should report "Very high." He should report "Very low" when the airplanes are just above the trees or ground. Airplanes are "low" when all of their details and markings are clear; "high" when the windows, markings, etc., cannot be seen. The observer should give his best estimate without delay.

Column 4. The observer underlines whether the airplanes were *seen* or *heard*.

Column 5. The code name of the observation post should be written in column 5 when the observer goes on watch. The code name will be assigned the observation post when organized.

Column 6. The observer indicates the direction of the airplanes from the observation post when they were seen or heard. The observer should orient himself as to directions as soon as he reports for duty. If the airplanes cannot be seen he should make his best estimate of the direction.

Column 7. The observer should indicate the distance of the airplanes seen or heard from the observation post. It will help if he picks out visible objects or landmarks whose distance from the observation post is known. These objects should be compared with the location of the aircraft for distance. When he cannot see the airplane the observer should estimate its distance; his best estimate is better than the commander's guess.

Column 8. The observer should indicate the direction in which the airplanes are traveling or headed. If he is properly oriented, this should not be difficult.

■ 39. OBSERVER'S PROCEDURE.—The following is a detailed list of operations for each observer going on duty:

a. He should fill in several message blanks in advance with the information to be indicated in line 1 and column 5.

b. He should take up a position at the observation post most favorable to see or hear airplanes.

c. Immediately when airplanes are seen or heard, he should note mentally all the details called for in columns 1, 2, 3, 4, 6, 7, and 8. He should not wait to fill in the flash message form but should rush to the telephone at the observation post, and call or dial the operator. When the operator says, "Number, please," he should reply "Army flash," followed by the telephone number of the observation post.

d. The observer should speak slowly and distinctly, directly into the mouthpiece of the telephone.

e. When the central operator hears the words "Army flash," the telephone operator immediately starts a high

priority, Government collect long-distance call to the Army filter center. While the operator is doing this, the observer should underline or otherwise properly fill in the flash message form. He should be ready to give the flash message when an Army operator answers and says, "Army, go ahead, please."

f. When the Army operator says, "Army, go ahead, please," the observer starts giving his flash message. He should talk in an even tone, speaking as distinctly as possible. He should not talk too fast. He should start the flash message by saying "Army flash" followed by the proper words marked or entered in columns 1 to 8, inclusive, on the flash message form.

g. When he has finished his flash message, the observer should wait until the Army operator has said "Check, thank you." When the Army operator says, "Check, thank you," he should hang up at once in order to clear the lines for other messages.

h. After he has hung up, the observer should retain the flash message form he has transmitted, and later hand it to the chief observer for file. The chief observer keeps a record of all actual flash messages sent.

■ 40. SPEED IN REPORTING.—Speed in reporting an observed flight is of extreme importance. It is assumed that the observer has started to telephone his report within 15 seconds after making the observation. It is of extreme importance that as little time as possible be consumed in observation of aircraft, getting to the telephone, and starting the flash message. The telephone personnel are trained especially to handle reports and have also established a minimum time by special telephone procedure. If the observer can do his part in 15 seconds or less, a very short over-all time will be required from observation to the Army information center.

■ 41. IDENTIFICATION.—As an aid to instruction for proper identification of airplanes, the regional signal officer will prepare identification charts for distribution to observation posts when possible. Reference should be made to FM 30-30, 30-31, 30-34, 30-35, 30-38, and 30-39.

SECTION IV

INSTALLATION OF INFORMATION AND FILTER CENTERS

■ 42. INSTALLATION.—The following instructions relate to the establishing of an information center:

a. *General.*—The design and lay-out of information centers should be drawn around the operations room (see fig. 13). This room is normally located centrally with respect to the space available. It always contains an *operations board* (or map), a *radar board*, and a *status board*, all on a large scale. It may contain such other boards or maps as may be found advantageous in utilizing the available space. When a primary or alternate filter center is directly associated with the information center, it is desirable that the operations room, the filter room, and the intercept room be grouped closely together and constitute an operating block. When practicable, this entire block should be located centrally with respect to the space available. Offices, equipment rooms, etc., can be arranged around and outside the operating block. Such an arrangement makes for more efficient tactical operations, decreases cost, requires a minimum of special ventilating equipment, and facilities sound proofing. When practicable, provision should be made for easy access by control personnel to platforms overlooking adjoining filter boards and intercept boards when these boards are a part of the information center.

b. *Mezzanine floor.*—Whenever practicable, the operation board should be surrounded on three sides by an overhanging mezzanine floor. When this is impracticable, a raised platform should be provided to insure a good view of the operations board, the radar board, status board, and other displays, by those primarily concerned. Provisions should be made for air circulation on the platform or mezzanine floor in rear of personnel disposed to view the several displays below. It is desirable that the floor of the platform or mezzanine be covered with sound deadening material so that the noise level may be kept to a minimum. When practicable, as much of the platform or mezzanine as is occupied by the control officer, pursuit officer, radio A officer, and radar officer, should be entirely inclosed and made soundproof with

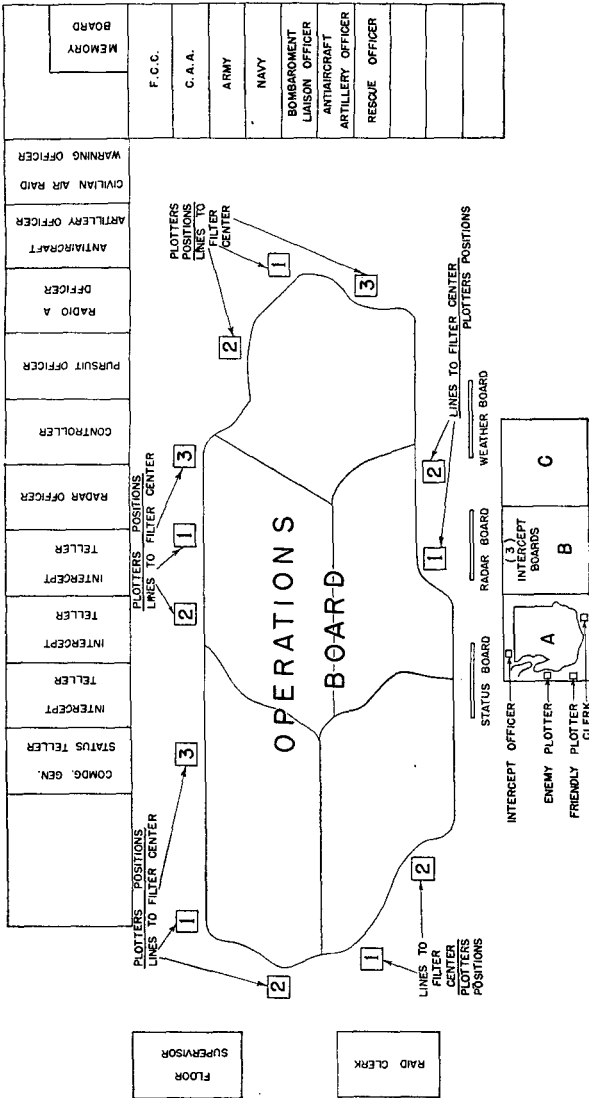

FIGURE 13.—Information center.

access doors, and glassed off from the main floor below. The radio A officer should be provided with a reasonably soundproof cabin, with glass overlooking the operations well, and glass on the side toward the pursuit officer and control officer. Local conference with agencies providing liaison officers will give a reasonably good index of their space requirements, and will facilitate the pay-out of positions on the mezzanine or platform. It is desirable to provide a narrow, short, flat surface on the mezzanine, extending backward from the operations well between the controller and the pursuit officer, and install thereon such switches and controls as may be in common use by both. This will decrease equipment requirements, and facilitate operations by avoiding mutual interference. Suitable map-boards should be provided in the form of partitions or partial partitions for the several liaison officers. Suitable wall display space should be provided for all control personnel on which weather maps, special instructions, and other data may be displayed. For the control officer, pursuit officer, and radar officer, display space should be provided in the rear of their position. Fluorescent lights should be utilized and should be so placed and directed as to avoid shadows on working or display surfaces. Control officers' position should directly face the vertical radar board in line with the center of the operations board. The radar officer and the pursuit officer should be on either side of and adjacent to the control officer. The radio A officer should be next to the pursuit officer. The air raid warning officer and the antiaircraft artillery liaison officer should, when practicable, be as near the radar officer as local arrangements permit. It is desirable in general that the air raid warning officer, the Federal Communications Commission liaison representative, and the antiaircraft artillery liaison officer be grouped together. The Civil Aeronautics Administration representative and the Army liaison officers should be grouped together when practicable.

c. Operations room.—Sufficient space should be provided around the operations board to permit personnel to sit when not actually engaged in plotting. The radar plotters, radar tellers, floor supervisor, and status board plotters must work on the operations room floor. This causes considerable congestion, and careful consideration must be given to each lay-

out to insure adequate working space. On the other hand, it is undesirable that displays be spread too far apart. Each layout can be made only when the space available is known. When practicable, it is highly desirable to provide forced ventilation to all parts of the operation block as a great number of persons are required to work in a very confined space.

d. Operations board.—The operations board for fixed installations should be made of wood, with a $\frac{7}{8}$ -inch plywood top, carefully joined and sanded smooth. The surface should be not less than 26 inches nor more than 34 inches high, depending upon the height of the ceiling. A height from 30 inches to 32 inches is best. A suitable wood frame and brace construction should be used. No point on any board should be over 8 feet from at least one plotter. Subject to this limitation, the scale of the map should be as large as practicable. The operations board for the average region will be to the scale of 1 inch equals 2 miles. One-piece inlaid vulcanized rubber mats will be provided for operations boards and filter boards at fixed installations.

e. Radar board.—It is desirable to plot radar reports by grid coordinates rather than by polar coordinates. The radar board should, therefore, be entirely covered by the master grid system. This board should be of as large a scale as space and plotting difficulties will permit. It should be mounted vertically, with the top as near the ceiling as possible, and the bottom high enough to permit unobstructed view from the control platform or mezzanine. This board should show the maximum coverage of each radar in or immediately adjoining the region, including inland coverage. Radar sites, airdromes, coverage circles, region and filter area boundary lines, boundaries between radar, and overlap areas should all be shown in colors conforming to those used on the operations board. The radar board is frequently constructed of metal so that magnetized plotting pips can be used.

f. Status board.—(1) While electrical remote control status boards are under development, a substitute must be used, and for this purpose a large blackboard is suitable. On the status board (fig. 14) a legend column at the left describes the various status conditions of the airplanes, such as availability, activity, and fuel remaining. A column is provided for each

squadron, and each squadron column is subdivided into six element columns. Eighteen horizontal spaces are provided, each opposite an item in the legend column. The legend column is divided from top to bottom as follows:

Available	} availability
Not available	
Ready	} degrees of readiness
Standby	
Alert	
Stations	
Ordered off	
In flight	
On intercept	} mission
On patrol	
On special	
Sighted enemy	
Returning to land	
Landed and refueling	
Fuel 1 hour	} fuel remaining
Fuel $\frac{3}{4}$ hour	
Fuel $\frac{1}{2}$ hour	
Fuel $\frac{1}{4}$ hour	

(2) A distance of 3 or 4 inches between horizontal lines and between adjacent element lines is adequate. Chalk markings will be used on the status board and therefore strong light should be provided. The status board should not be used for anything except immediate information. Data as to when aircraft will become available, etc., are kept by the pursuit officer at his position. A simple X is the only entry required in any space other than the legend spaces and the spaces provided for identification of squadron, elements, and airdromes. It is desirable that the status board be as high as possible so as to permit unobstructed vision for the mezzanine personnel.

■ 43. OPERATIONS BOARD AT COMMAND POST, INTERCEPTOR COMMAND.—*a. Arrangement.*—The interceptor commander, or his representative on duty, requires the display of—

- Information of enemy air movements.
- Status of friendly pursuit.
- Weather conditions.

The best general arrangement is the provision of a large horizontal operations board covering the entire air defense area, a platform overlooking the operations board, a vertical

ELEMENTS	FIELD SQUADRON						FIELD SQUADRON					
	1	2	3	4	5	6	1	2	3	4	5	6
AVAILABLE												
NOT AVAILABLE												
READY												
STAND BY												
ALERT												
STATIONS												
ORDERED OFF												
IN FLIGHT												
ON INTERCEPT												
ON PATROL												
ON SPECIAL												
SIGHTED ENEMY												
RETURNING TO LAND												
LANDED AND REFUELING												
FUEL ONE HOUR												
FUEL $\frac{3}{4}$ HOUR												
FUEL $\frac{1}{2}$ HOUR												
FUEL $\frac{1}{4}$ HOUR												

FIGURE 14.—Status board.

status board, and a vertical weather board so disposed as to be readily visible by control personnel. The status board and the weather board are both outline blackboards on which

suitable entries are made in chalk for instant reference. They may be mounted in a line or at an obtuse angle to each other, as determined by the space available.

b. Interceptor command operations board.—This board should be of the same material and construction as the regional operations boards. It should show mainland and sea areas, airdromes, regional boundaries, prominent landmarks, master grid system, and location of region information centers. The board should be of uniform scale and of such a size that no point on the board is over 7 feet from at least one plotter.

c. Status board at interceptor command post.—This should be identical with the boards provided at regional information centers, except with reference to the number of units covered.

d. Weather board.—The weather board is an outline map painted in yellow lines $\frac{1}{4}$ -inch wide on an ordinary black-board. Meteorological information is displayed on this board by a code involving colored chalk lines, and letters as follows:

(1) Colors refer to altitude.

	<i>Feet</i>
Red-----	0-500
Green-----	500-1,000
Yellow-----	1,000-4,000
Blue-----	4,000-10,000
White-----	above 10,000

(2) Lines refer to cloud conditions.

Crossed slanting lines—overcast.

Horizontal lines—broken.

Vertical lines—scattered.

(3) Superimposed letters refer to other meteorological conditions.

V—visibility less than 3 miles.

S—snow.

R—rain.

W—wind over 35 miles per hour.

I—icing conditions.

T—extreme atmospheric turbulence.

F—fog or visibility under 1 mile.

e. Platform or mezzanine interceptor command post.—It is particularly important that a high platform or mezzanine be provided for overlooking the large operations board be-

cause of the size and scale of the map. The mezzanine should provide space for not less than five persons, and should, when practicable, be glassed off from the floor below.

■ 44. **FILTER CENTERS.**—Filter centers will invariably perform filtering and air raid warning functions. When necessary or advisable, antiaircraft artillery, Federal Communications Commission, and other liaison officers will obtain information direct from filter centers, in which case the boards are classed as primary and alternate, the latter being reduced in scope and size and materially simplified.

■ 45. **PRIMARY FILTER BOARD ROOM.**—Filter rooms are constructed and laid out around the filter board. They are simple installations, consisting essentially of the filter board and a mezzanine or platform overlooking the board. The height of the mezzanine above the filter room floor will ordinarily be limited by ceiling heights, but should be as near 6 or 7 feet as practicable.

■ 46. **PRIMARY FILTER BOARD.**—This board is to the scale of 1 inch equals 1 mile whenever practicable, subject only to the limitation that no part of the board will be over 7 feet away from each plotter. The table and surface should be outlined in the same manner as was described for the operations board. Three plotters are provided for each reporting area, with alternative capability for receiving information of and plotting in adjacent areas. Each filter board should cover the entire filter area, plus at least a 20-mile overlap in all directions. More overlap may be required where overlap telling circuits are toll terminals rather than full-talk and when filter area boundaries are close to important objectives. The boundaries of reporting areas are determined by estimating the plotting capabilities of three plotters under the air traffic conditions anticipated. The greater the rate of enemy air operations, the smaller the reporting area, and vice versa. Generally speaking, each filter area will consist of not less than three nor more than seven reporting areas. The first letter of the code name of the reporting area (not the grid system) should be painted on the map in the center of the reporting area, in the same color as the reporting area boundary. This letter should be 1 foot high, and

painted in 2-inch width. Each letter should be oriented with respect to the teller who reports to the operations board for the area.

■ 47. FILTER CENTER MEZZANINE OR PLATFORM.—The platform overlooking the filter center board should not be glassed off from the floor below. It should provide ample space for the tellers, supervisors, and others required in the specific area. The personnel on the platform will vary with the nature and location of the filter center. In the case of a filter center associated with an information center, it is highly desirable that the mezzanine overlooking the filter board be an extension of the operations mezzanine, so that control personnel may have ready access to view the filter board.

■ 48. ALTERNATE FILTER CENTER.—In order to provide for alternative means of filtering in the event of failure of any filter center, alternate filter centers should be provided in each case. As a general rule, these alternate filter centers should be associated with an information center or a primary filter center of another area, and should not require the provision of an entirely new installation. Alternate filtering facilities should be reduced in scale and scope. Ordinarily one or at the most, and exceptionally, two plotters per reporting area should be provided. In many instances alternate filter boards can be mounted vertically, and may be plotted in pencil on an overlay. No specifications for alternate facilities are prescribed, each lay-out being planned to meet the requirements of the specific locality and condition. In general, alternate facilities should be as simple as practicable, but capable of carrying out primary functions on a minimum basis.

CHAPTER 4

SIGNAL COMMUNICATION SYSTEMS

	Paragraphs
SECTION I. General.....	49-56
II. Communication Installation.....	57-62

SECTION I

GENERAL

■ 49. **PURPOSE.**—The purpose of this chapter is to clarify the employment of signal agencies available to the Aircraft Warning Service.

■ 50. **REFERENCES.**—This chapter is based upon Field Service Regulations (FM 100 series) and is supplementary to FM 24-5 and FM 11-5.

■ 51. **SIGNAL SYSTEMS.**—Signal communication systems as employed in the Aircraft Warning Service are the same as those employed in other services, being augmented in certain operations by the facilities of the commercial telephone systems in particular locations, and such commercial radio broadcast stations as may be of value in the tactical situation.

■ 52. **EMPLOYMENT.**—The employment of all military signal communication systems within the Aircraft Warning Service will conform to the methods and forms promulgated in Army Regulations and other authoritative directives and publications; this also applies to the installation, operation, and maintenance of all equipment. The employment of the commercial telephone facilities will conform to directives and such other publications as may be issued from time to time together with certain procedures and methods set forth in this manual. In the employment of communications in a fixed installation, the Aircraft Warning Service will follow a standardized plan so as to simplify operation and training of operating personnel. Although no two situations will be exactly the same, especially in areas where mobile units will function, and in which the communication system must fol-

low a plan based upon a clear knowledge of the situation, the standardized procedure will be followed as closely as possible. Aircraft Warning Service (fixed installations) communication systems will depend greatly upon commercial communication facilities. In thickly populated areas, the communication facilities are generally well set up and dependable. In sparsely settled areas, the communication units of the Aircraft Warning Service, augmented by the signal construction battalion, will be relied upon to install, maintain, and operate complete communication systems.

■ 53. AGENCIES.—*a.* In general, agencies of communication provided will be governed by the tactical situation. All means of communication necessary to carry out the interceptor commander's plans will be provided. In all installations, the communication systems will be as complete as time and facilities will permit.

b. The principal means of signal communication within the Aircraft Warning Service will be telephone, augmented where necessary by teletypewriter, radio telephone, radiotelegraph, and wire telegraph. The use of teletypewriter should be limited to administrative purposes and those requiring a record of transmission and delivery. In the plan of communication for Aircraft Warning Service, due consideration should be given to the establishment of all means of signal communication, and a procedure instituted to insure a quick and rapid conversion of the various means completely, or in part, so that reliable communications can be maintained. The following types of communication are provided for:

Telephone.

Teletypewriter.

Telegraph.

Radio.

Panels.

Messenger.

All the various means should be installed or held in readiness in order that they may be utilized when required with the least possible delay.

■ 54. RESPONSIBILITY.—The responsibility for communication systems of the Aircraft Warning Service rests with the signal officer. He has the responsibility of installation, mainte-

nance, and coordination with other units for tactical control of communication systems. The importance of direct supervision must be stressed, for no communication system can function effectively without complete coordination and supervision.

■ 55. COORDINATION.—There must be complete coordination with other communication systems, such as naval, Government, and commercial systems. In large defense areas, the commercial systems will be utilized to the fullest extent. As soon as a definite plan has been set up in accordance with the needs of the defense commander, the unit signal officer will ascertain what communication systems are available for the Aircraft Warning Service. He will coordinate (when directed by higher authority) with other using agencies to determine the portions of the existing systems that can be utilized to complete successfully the air warning communication system without interrupting other activities that are important to the defense area.

■ 56. FACTORS GOVERNING EMPLOYMENT OF COMMUNICATION EQUIPMENT.—The means of communication employed will depend upon the time limit for installation. The unit signal officer will use judgment in establishing communication systems so that the system will be ready to function when needed. It is a known fact that radio communications are becoming more difficult due to the crowding of the frequency bands; therefore, radio should be used only as a method of quick installation of communications, and should be supplanted by wire circuits where and whenever possible. The fact that many restrictions have been placed on the use of radio for purposes of maintaining secrecy will also govern its employment. Due to the necessary and extensive use of communications within a theater of operations due care must be used in the original lay-out of the system so that it will be flexible and capable of rapid readjustment to the needs of the changing situation. The following chart, figure 15, shows type organization of the air force in a theater of operations. The chart will give an idea as to the number of units requiring complete communication systems.

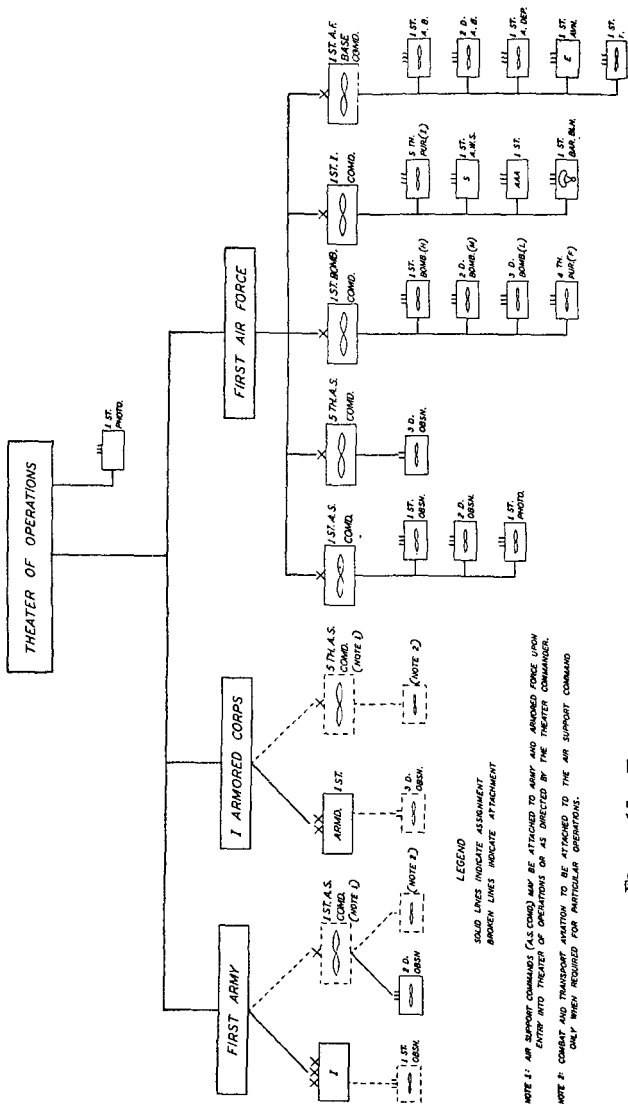

FIGURE 15.—Type organization of air force in theater of operations.

SECTION II

COMMUNICATION INSTALLATIONS

■ 57. WIRE LINES.—As stated, wire lines will be utilized wherever and whenever possible for communications. Within the continental United States, commercial wire lines should be used to the maximum extent feasible for fixed or mobile installations. In some cases the communication units of the Aircraft Warning Service will be required to install additional circuits to augment the commercial circuits. All units of the Aircraft Warning Service have sufficient equipment and wire for local installation. Certain situations will call for the establishment of long lines beyond the possibilities of communication units of the Aircraft Warning Service; in these situations the signal construction battalion will be utilized. No unit should be without communication to its superior units, subordinate units, or adjacent units longer than is necessary. The installation and operation of wire line circuits will follow the instructions of FM 24-5 and FM 11-5. Due to the rapid changes being made in technical equipment for telephone communication in the Aircraft Warning Service, technical operation or installation will not be taken up in this manual.

■ 58. TELETYPEWRITER.—Teletypewriter is a means of communication used extensively where records of transmission are required or for administrative communications. Teletypewriter circuits can be used for reporting information from radar stations; providing a suitable circuit with equipment and trained operating personnel is available, rapid reporting can be obtained by teletypewriter. In the higher units, teletypewriter circuits will be required for various uses; the reporting of plane arrivals and departures is essential to the interceptor and regional commanders. Teletypewriter equipment in series affords an excellent means of reporting information to several locations simultaneously, thereby leaving a record for future reference.

■ 59. TELEGRAPH.—The telegraph set TG-5 or TG-5-A will be used to increase communication channels to outlying units, and equipment will be made available for simplex circuits. It may be found that communication over wire lines can be

had with the telegraph set TG-5 when the talking circuit is useless. Refer to TM 11-351 for instructions relative to the TG-5 and TG-5-A.

■ 60. RADIO.—Instructions governing the establishment of all radio networks, the operating procedure, and the maintenance of radio station records and logs will be found in FM 24-5, FM 24-6, and TM 11-454; for characteristics and use of radio refer to FM 11-5. The employment of radio by the Aircraft Warning Service will be supplementary to the telephone. Telephones are essential to insure speed and accuracy in transmitting data from an observation post to a filter center. Other factors which restrict the use of radio are the small number of noninterfering frequency channels available, and the requirement of secrecy in transmitting messages. Where the Aircraft Warning Service is operating in the field, and the installation of the telephone and teletypewriter lines has not been completed, the use of radio will for a time be the principal means of signal communication; however, as soon as the telephone circuits have been completed between a reporting platoon and the filter or information center, that portion of the telephone net will become the principal means of communication between the two points involved.

■ 61. PANELS.—The panel set AP-30-B is issued for fixed installations of the Aircraft Warning Service, and is used for communication and identification between ground troops and aircraft. The care and use of panels is fully covered in FM 24-5.

■ 62. MESSENGER SERVICE.—Messengers will be used where essential. The messenger service of the interceptor command will be well organized, using selected personnel. Messenger service will not be used where other means of communication will suffice. This service will be used for the purpose of transmitting bulky matter, such as maps, reports, etc. Such service as the Army Air Forces mail plane system and the air transportation used in the supply system will afford means of reaching inaccessible locations and greatly facilitate and expedite the transmittal of necessary matter. The overloading of messenger service greatly reduces its efficiency; therefore, a close coordination with other means of transmittal is essential.

CHAPTER 5

OPERATIONS

Paragraphs

SECTION I. Operation of information and filter centers----- 63-94

II. Duties of information and filter center personnel. 95-111

SECTION I

OPERATION OF INFORMATION AND FILTER CENTERS

■ 63. GENERAL.—*a.* An area to be defended is divided into regions. Each region is composed of one or more filter areas. These, in turn, are divided into smaller reporting districts. Filter board plotters are provided for each reporting district. Their purpose is to receive information from observation posts and translate the information to the proper location on the surface of the filter board.

b. Three plotter positions are provided for each reporting district of the filter board. Their positions are as follows (see fig. 16):

No. 1—in the center of the district.

No. 2—to the right of No. 1 facing the map.

No. 3—to the left of No. 1 facing the map.

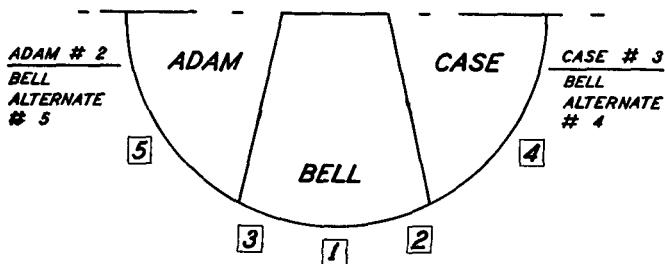

FIGURE 16.—Plotters' positions.

In addition, the immediately adjacent plotter positions of the two adjoining districts are designated as alternate plotting positions for the district in question.

■ 64. OPERATION OF TELEPHONE EQUIPMENT (FILTER CENTER).—*a.* Incoming calls will be routed to idle plotters in sequence as follows: first to No. 1 position, if idle, or if that position is busy, to the No. 2 position. If both plotters Nos. 1 and 2 are busy, the call will reach plotter No. 3. In case all three reporting district plotters are busy, the call will be routed first to alternate position No. 4 in the adjacent district or, if that is also busy, to alternate position No. 5. When an incoming call reaches the filter board, the plotter will receive a zip tone in the headset if the call comes on the primary line, and a lamp associated with the plotter answering key will light to indicate the line on which the call is waiting. If an incoming call comes in on any other line, the lamp signal only will be received.

b. Plotters are provided with incoming telephone equipment as follows:

(1) No. 1 position has access to one or two incoming lines, depending on the particular filter board. The position has a key and associated lamps. To answer the call the plotter will operate the key in the direction indicated by the lighted lamp. The upright position of the key is the normal or disconnect position. On the termination of the call, the answering key *must be returned to normal*.

(2) Nos. 2 and 3 positions have access to one, two, or more than two incoming lines depending on the particular board. If position has either one or two lines, the operation is similar to that outlined for No. 1 position. If more than two lines terminate on the plotter's equipment, the plotter will have a key and a button set with six buttons and associated lamps. The upright position of the key will be the normal or disconnect position. When answering an incoming call, the answering key will be operated and the button associated with the lighted lamp will be depressed. On termination of the call, if a call is waiting on another line, as indicated by a lighted lamp, the plotter may depress the associated button without returning the answering key to normal. If, however, there is no waiting call, the key *must be returned to the normal position*. All lines on the button set should be answered immediately with the exception of those that appear also on position No. 1. In this case, plotter No. 1 should be answered by plotter No. 2, and if No. 2 is busy, No. 3 will take the call.

As plotters Nos. 2 and 3 are the alternate plotters for the adjoining reporting districts, they will occasionally receive information that they will have to plot in adjoining reporting districts.

■ 65. PLOTTING EQUIPMENT.—The following equipment is used for plotting:

a. *Round number disks.*—These are marked U (unknown number), F (few), M (many), 1, 2, 3, .3., (more than 3), 6, .6., 9, 10, .10., .15., .20., .25., .30., .40., .50., .75., and .99., and are used to indicate the number of planes reported. Twenty of each type disk are located in a bin for use in each reporting district.

b. *Plotting pips.*—These pips will be kept in the plotter's apron. Pips consist of a square block, a five-sided block, and

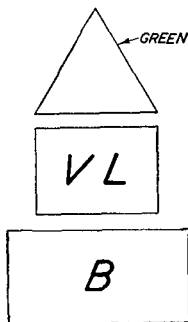

FIGURE 17.—Pip for plotting.

an arrow mounted on a single axis. The pip is used as follows: The five-sided block has sides marked VL, L, H, VH, and U (meaning very low, low, high, very high, and unknown) and is used to indicate the altitude reported. The square block has sides marked U, M, B, and S (meaning unknown, multi-motor, bimotor, and single engine airplanes) and is used to indicate the type of plane reported. The arrow has two sides, one painted green and one painted red (green indicates that the reported aircraft was seen, and red indicates that it was heard). The pip is placed flat on the board so that the direction of the arrow indicates the direction of flight on the ob-

served planes. Figure 17 shows a pip rotated to read, "Bimotor planes flying very low and seen."

c. Answering calls.—(1) Answer with, "Army, go ahead please."

(2) If the answer to (1) above is not the word "Flash" or "Overlap" (see par. 39a), you have received a call not intended for the Army, and you will then say, "You have been connected with a wrong number; hang up, please, and make your call again." Upon this statement, disconnect. To terminate the call after the flash message has been received say, "Check, thank you," and disconnect.

■ 66. PLOTTING CALLS FROM OBSERVATION POST.—*a.* Form No. 1 is a copy of the flash message form used by observers and will be read to you over the telephone. An example of a received flash message is as follows: "Flash—3—Bimotor—Very low—Seen—Dudley 20—NE—2—West," meaning, "Three bimotor planes flying very low were seen 2 miles northeast of observation post Dudley 20 flying toward the west."

b. As the above message is being received, the plotter performs the following operations:

(1) Selects the correct number disk indicating the number of planes reported and places it on the filter board.

(2) Rotates the parts of the pip so that the type of planes, altitude of planes, and whether seen or heard are indicated on one surface.

(3) Locates the observation post making the report on the filter board and places the number disk over that post location.

(4) Places the pip with information facing upward at the point on the board indicated by the reported direction and distance from the observation post. Points the arrow in the direction of flight; 4- and 6-foot rakes will be provided in order to reach all points in the reporting district.

■ 67. PLOTTING OVERLAP CALLS.—Besides plotting calls from observation posts you will receive and plot overlap information from adjoining filter boards and radar boards. This information will be received from overlap tellers by plotter No. 3 or No. 2 and will be plotted in the overlap area, the shaded area 20 miles outside of your filter boundary. The call will be received in the following sequence: "overlap," target num-

ber, color of the arrow, location of the arrow (grid coordinates), direction of flight, number of planes, type of planes, and height of planes. The plotter will plot the information with the specified colored arrow and place near the arrow a multisided pip with base on table surface and pointing upward. The pip will be rotated so that the side of the square block indicating the type of plane, the side of the pentagonal block indicating height, and the face of the arrow (red side meaning enemy, and green side meaning friendly) are in the same horizontal plane.

■ 68. PLOTTING BY GRID COORDINATES.—Overlap plots will be located by using the following system of grid coordinates: Figure 18 illustrates the location of a point in this manner.

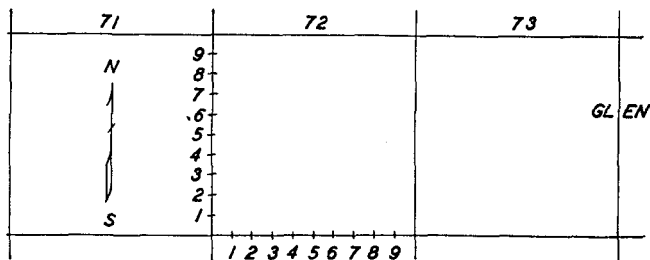

FIGURE 18.—Grid system.

Areas between grid lines running north and south are indicated by number. Areas between grid lines running east and west are indicated by name. To read the area in which a point is located, read north and south grid number first, then east and west grid name. For example, the point in figure 18 is located in area 72 Glen. To spot the point in the area, mentally divide the horizontal and vertical sides of the area each into 10 equal parts numbered zero to nine. Using the lower left corner 00, read horizontally the point at which a vertical projection of the point to be spotted cuts the horizontal edge of grid area. Then read vertically the point at which the horizontal projection of the point to be spotted cuts the vertical side of the grid area. For example, the exact location of the spot in figure 18 is 72 Glen 73. The position within a grid square is always reported

as so many units over and then so many units up. This sequence (over then up) is *never varied*. The grid coordinate location of the arrow is always told as the location of the tail of the arrow for both fixed and mobile radar boards.

■ 69. EQUIPMENT (FILTERER).—Each filterer will be provided with a three-pocket apron, a supply of red, green, and blue arrows, and a filterer's set. The apron is used to hold the colored arrows in its three pockets. Colored arrows are used in place of the pips to show the course of planes. The filter-

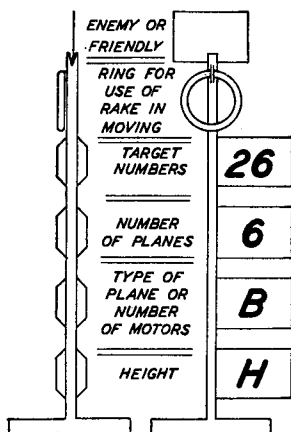

FIGURE 19.—Target display stand.

er's set includes target display stands and a box of rectangular card indicators. Figure 19 shows the target display stand.

■ 70. TARGET DISPLAY STAND.—The target display stand has nine clips. In clips one and two, duplicate cards indicating height should be placed. Clips three and four hold duplicate cards showing type of plane or number of planes. Clips five and six hold duplicate cards indicating target numbers. Clip nine holds a card indicating enemy or friendly. The set of card indicators is located on a table in the filter room and includes—

a. Cards indicating height—VL (very low), L (low), H (high), VH (very high), and U (unknown).

b. Cards designating type of plane by number of motors—S (single motor), B (bimotor), M (multimotor), and U (unknown).

c. Cards showing type of plane, yellow in color—B (bomber), F (pursuit or interceptor command forces), N (navy), O (observation), R (reconnaissance), T (miscellaneous commercial airplanes), X (experimental), IB (indicating bomber command forces), IN (indicated Navy forces).

d. Cards showing number of planes—1, 2, 3, .3. (more than three), 6, .6. (more than six), 9, 10, .10., .15., .20., .25., .30., .40., .50., .75., .99., F (few), and M (many).

e. Cards indicating enemy or friendly—green (friendly) and red (enemy).

f. Cards indicating target—Nos. 1 to 50, inclusive.

g. Blue chips to be attached to top of target number to indicate that the flight number was assigned in an adjacent region. When using the yellow cards showing type of plane, the indicating cards will be used unless type is verified by the raid clerk. If verified by raid clerk, single letter cards will be used.

■ 71. SYSTEM OF FILTERING.—a. Time is determined by a clock with the hour hand removed. It is hung in a prominent position and has each 5-minute space colored consecutively red, green, and blue; taking any quarter hour commencing from the quarter, the first 5-minute space is colored red, the second green, and the third blue. In making filtered plots, use colored arrows of color similar to sectors of the clock. That is, if the hand of the clock is in the red space, use red arrows. The arrows replace the pips used by the plotter and are placed on the board in the exact location of the pip to indicate the path of the reported flight. These plots will be made with arrows which correspond to the color of time intervals indicated by the clock. If red arrows have just been used, green arrows will be the next color to be employed as shown by the clock. Green will be followed by blue arrows. Tracks indicated on the board will never be allowed to be more than 15 minutes in length, that is, when

an arrow color starts to be duplicated, all arrows of the duplicated color will be removed from the board.

b. In addition to arrows, use target display stands to indicate the filtered information describing the target. Only one stand for each flight will be required and will contain the latest filter information. Place the stand adjacent to the most recently placed colored arrow. Display the information on the stand as described in paragraph 70. When a target number is assigned by the raid clerk, this information will come either verbally from the supervisor, or from a plotter connected with the supervisor. The target number is then placed in the correct holder on the stand.

■ 72. METHOD OF FILTERING.—The filter plotter is charged with taking the information as supplied by the ground observers, which appears on the board as plotted by the plotters, and evaluating this information so that the information given by the filtered track will be as nearly correct as possible. This operation is necessary as the information received from the ground observers concerning any one target will vary. No two persons are able to make the same report on the observed flight, due to the human element as well as the different conditions under which the successive observations are made. For this reason, it is necessary that the plotter take these varying reports and reduce them by a process of mental evaluation to the correct report of the position, direction, height, and composition of the raid. The deductions made in this process are based upon plain common sense, a slight knowledge of what an airplane or formation of airplanes can do, and a knowledge of the normal errors that are made by observation. Skill in this operation will come only with practice and experience. A few general rules and an outline of the mental process can be laid down at this time but will be changed, corrected, and added to, as experience is gained in this type of work. Paragraphs 73 to 79, inclusive, indicate some of the general considerations.

■ 73. FILTERING SPEED.—Targets will continue across the board at a fairly constant rate of speed. These speeds will vary, with present types of equipment, roughly between 150 and 300 miles per hour. Speeds will not change for short periods but will tend to hold an average over a given length of time. Therefore, in spite of the fact that successive plots

coming through show that the speed of the target is jumping up and down, it is logical to assume that the target is maintaining a constant speed, and that the changes indicated on the board are due to delays in the reporting system. The plotter not only places arrows on the reported position of the flight, but he may also place additional arrows between the plotted positions so as to present a better picture of the path of the raid to the tellers. Thus, he will keep the track moving smoothly across the board, but he will never place "fill-in arrows" in front of the latest plot.

■ 74. **FILTERING ALTITUDE.**—In filtering the altitude of the raid, the above line of reasoning also holds true. That is, aircraft do not normally make large changes in altitude in jumps up and down. Therefore, if successive reports come in indicating a given flight "reporting altitude," as VH, then H, then VH, then L, then H, this information should be changed by the filtering process to either H or VH, if no other factors are present to aid in making the decision. H or VH was chosen as the correct altitude for the target by mentally averaging the altitude of the reports given. If the next series of reports reads H, VH, H, H, L, L, L, it would indicate that the flight was losing altitude and that the correct altitude marker should be L.

■ 75. **FILTERING TYPE OF PLANES.**—The decision is much easier to make in filtering the type of planes observed, because the aircraft cannot change the number of its engines. Therefore, the reports should nearly always be the same, except for the normal mistakes in reporting the information.

■ 76. **FILTERING NUMBER OF PLANES.**—In the process of determining the correct number of planes in a formation, the same lines of reasoning are followed, because again we have a simple problem of arriving at a logical average from the different reports received. In cases where this decision must be made, it is better to pick a number higher than the mathematical average, to be on the safe side.

■ 77. **FILTERING FRIEND OR ENEMY.**—The identification of a target as friendly or enemy is not made by the plotter, but is made by the raid clerk and will be discussed in a later section.

■ **78. FILTERING COURSE.**—The determination as to the true track the target is making on the map is again a process of averaging between the various spots that are determined by the position of the plotter's pips. If the line of plotter's pips advances in one general direction, the chances are very great that the flight path is along a straight line between the pips. Some of the pips will be to one side of this line and others to the other side. The correct line is determined by visual inspection, using a good average of the number of plots on each side, the distance of each plot to the side being taken into consideration. If the line of plots makes a turn, it is naturally assumed that the flight has turned in the same manner.

■ **79. FILTERING UNKNOWN DATA.**—In filtering unknown data, a few other conclusions may be drawn. If the target is heard and not seen, the number of engines must be listed as unknown. When the target is heard and not seen, the number of airplanes can only be stated as few or many, and the indication is not very reliable. If the target is heard and not seen during daylight hours, it may be assumed to be above the lower level of the cloud layer. Therefore, altitude information will be fair up to the cloud limit, and unknown above that limit.

■ **80. REPLACING PIP WITH ARROW.**—While the plotter is making the above decisions about plots of any one track, he will place the deduced information on the target display stand and then replace the plotter's pip with an arrow. This arrow will be placed in the correct position and direction found by the filtering process. The color of the arrow will correspond with the clock color code as described in paragraph 71a.

■ **81. EQUIPMENT OF TURRET SUPERVISOR.**—The turret supervisor has a cabinet with a multiple of all army flash lines incoming to plotters' positions. These lines have lamps and associated keys. The supervisor also has a key which when operating one way will enable him to talk, or the other way, to listen on the circuit. The key will be marked to show the direction in which to operate for talking or listening. When there is an incoming call to a plotter's position, the answering (white) lamp associated with that line will also light in the supervisor's cabinet. When the plotter answers, the answer-

ing lamp will go out, and the busy lamp (green) will light and remain lighted until the plotter disconnects. To answer or listen in on an incoming call, operate the key associated with the supervisor's telephone instrument to talking or listening position, as desired. Then operate the key (in the cabinet), associated with the lighted lamp, toward the lamp.

■ 82. DUTIES OF TURRET SUPERVISOR.—It is the duty of the turret supervisor to see that all calls on the filter board are answered promptly and plotted correctly. By observation of the turret equipment the speed with which incoming calls are answered by the plotters can be determined. It is essential that no time be lost by having waiting calls. The supervisor is, therefore, responsible for seeing that calls are answered immediately. When all plotters are busy, the supervisor must answer the incoming calls at the turret, and transmit the information to the next available plotter. The supervisor must understand plotting technique thoroughly, and see that correct operating technique is carried out by the plotters. Thus, the supervisor must monitor calls, and give instructions when necessary to plotters. Over direct lines from the raid clerk in the information center, the turret supervisor receives identification of flights and targets, assignment of numbers, or any change on target display stands. This is passed on to the No. 3 position plotter of nearest area for necessary changes on filter board.

■ 83. EQUIPMENT OF FLOOR SUPERVISOR.—The floor supervisor will have a six-button key set with lamps, headset, and buzzer. This equipment has lines to the controller, raid clerk, and administrative P. B. X. To answer an incoming call when the answering lamp lights and the buzzer sounds, depress the button associated with the lighted lamp. Incoming calls from the administrative P. B. X. are indicated by the telephone bell, and are answered by depressing the button associated with the line. To originate a call, depress the key associated with the desired line. To disconnect, restore the key to normal position.

■ 84. DUTIES OF FLOOR SUPERVISOR.—The floor supervisor—
a. Maintains discipline in the filter room.
b. Is in charge of the filter board under the direction of the regional signal officer.

c. Maintains proper manning of the filter board under the direction of the regional signal officer.

d. Relays any instructions from higher authority.

e. Maintains a floor supervisor's log in which are recorded all instructions as passed to the floor supervisor. This log is to be turned over to the officer in charge for daily check.

■ 85. TELLERS TO OPERATIONS BOARD.—*a. General.*—Tellers to the operations board are located on the balcony overlooking the filter board. The tellers are connected directly by telephone to operations board plotters. The teller's telephone set is connected by operating a lever key. The purpose of the teller is to relay all filtered information from his part of the filter board to a similar part of the operations board.

b. Information to be told by operations board teller.—From that part of the board assigned to the teller, the teller tells each plot, as it is filtered, to the operations board plotter on the end of the telephone line. The teller will know that a plot has been filtered when the filterer substitutes a colored arrow for the plotter's pip. The teller reports also the target display stand as set up by the filterer. Explanation of the target stand is found in paragraph 70.

c. Sequence in telling.—(1) Use the following standard form in telling—

(a) Target number if assigned.

(b) Color of the arrow.

(c) Grid location of the tail of the arrow. (Grid system is explained in par. 68.)

(d) Direction of flight.

(e) Friendly or enemy identification.

(f) Number of planes.

(g) Type of planes.

(h) Height of planes.

(2) Items (a) and (d) to (g) inclusive, above are read from the target display stands described in paragraph 70. An example of telling is: Target 13, red, 72 Klaxen 31, north, friend, three, bimotor, high; meaning that the plotter of target No. 13 has placed a red arrow with tail at 72 Klaxen 31 and pointed toward the north, and that there are three bimotor planes flying high.

■ 86. TELLERS TO INTERCEPT BOARD.—*a. General.*—Tellers to

the intercept board are located on the balcony overlooking the filter board. For each intercept board, there is one teller available at the filter board who is connected directly by telephone with the intercept plotter. The teller's telephone is connected by operating the key.

b. Information to be told.—The intercept plotter will notify the teller of a particular target number that he wants followed. The teller gives all information appearing on the filter board concerning each new filtered plot of that target.

c. Sequence of telling.—See paragraph 85c.

■ 87. OVERLAP TELLER.—*a. General.*—There is an overlap teller for each adjoining filter area. Overlap tellers tell plotters in adjoining filter areas. Overlap tellers are located on the balcony of the filter room. The overlap teller's telephone equipment includes a key, lamp, nonlocking push-button ringing key. To answer an incoming call when the lamp lights, operate key. To connect plotter, push button as indicated on designation strip. To originate a call to an adjoining filter board overlap teller, operate key and depress the single push button ringing key for about a second.

b. Information to be told overlap teller.—The teller will tell all flights that are in the shaded overlap area both inside and outside of the filter boundary in the sector adjacent to the filter area to which he is telling. He will not tell those flights in this area that have just been told to his board as overlap from the adjacent filter board.

c. Sequence of telling overlap plotter.—First, the teller gives to the adjoining overlap teller the reporting name of the area in which the overlap is to be plotted. This is given in a single word which is the name of the reporting area. The adjoining overlap teller will connect him to the correct filter plotter, who will answer, "Army, go ahead, please." He then knows that the plotter is ready to plot his telling; so, he says "Overlap," and then proceeds with telling.

d. Overlap from adjoining filter board.—In case the overlap is to be told to the teller's filter board, he will hear the adjoining filter board overlap teller give an area name. He will then operate his key to place the correct filter plotter into the circuit.

■ 88. OPERATIONS BOARD PLOTTER.—*a. General.*—The opera-

tions board is similar to the filter board, but combines all filter areas of the region to make one large operations board. A plotter for each filter area on the operations board is connected by direct telephone to a teller located at the filter board. The plotter plots on the operations board the tracks that appear on the filter board as told by the teller.

b. Telephone equipment.—Operations board plotters have telephone headsets, and either one-way or two-way lever keys with one or two associated lamps. To occupy the position, connect the telephone set to jacks, and operate the lever-type key if a one-way key. To answer incoming calls on one-way key equipment, no further action is required if the lever key is kept operated. If the key is in the inoperative position, incoming calls will be indicated by the lighted lamp, and may be answered by operating the key. Disconnect by returning lever key to normal only when vacating position. If the plotter's position has a two-way key, connect the headset in a similar manner, and answer incoming call by operating lever key to the normal position. Where more than one plotter has duplicate connections to the same teller, each plotter will listen to call, and that plotter who is stationed in the most advantageous position will plot the call.

c. Plotting equipment for operations board plotter.—The operations board plotting equipment is described in paragraphs 69 and 70. In addition to the equipment there described, the plotter will have at his position a long and short rake for assistance in plotting.

d. Method of plotting at operations board.—(1) If not already connected with the teller, the plotter will answer with "Go ahead." An example of what the teller will tell the operations board plotter can be found in paragraph 85c. This information will be plotted in the same manner as described in paragraph 70.

(2) The following information will be plotted on the board in the sequence indicated:

- (a) Target number.
- (b) Color of arrow.
- (c) Grid location.
- (d) Direction of flight.

(3) The following items are put on the target display stand:

- (a) Friendly or enemy.

(b) Number of planes.

(c) Type of planes.

(d) Height of planes.

(4) When the plotter at the information board has received all the information from the teller, and he is sure that he has received the information correctly, the plotter terminates the call by saying "Check." Plotters will remove 15-minute-old plots at the beginning of each 5-minute interval as controlled by the color clock code.

■ 89. TELLERS TO INTERCEPT BOARD.—*a. General.*—Tellers to the intercept board are located on the balcony overlooking the operations board. The tellers are connected directly by telephone to the intercept board. The purpose of the teller is to relay all enemy target information plotted on either the operations board or the radar board to the intercept board.

b. Telephone equipment.—The teller's equipment includes a headset, one-way lever key with associated lamp, and single push-button ringing key. To occupy position, operate lever key. To answer, no further action is required if lever key is in operated position. Incoming calls are indicated by the lighted lamp and a monotone heard in the receiver. If lever key is not operated, operate it. To originate a call, lever key should be operated. Push-button key should be depressed for about a second to ring.

c. Information to be told to interceptor board.—Tell each plot of all *enemy* targets within the regional boundary. Report colored arrows and target display stands as described in paragraphs 70 and 71.

d. Sequence of telling.—Use the standard form in telling—

(1) Target number if assigned.

(2) Color of the arrow.

(3) Grid location of the tail of the arrow. (Grid system is explained in par. 68.)

(4) Direction of flight.

(5) Number of planes.

(6) Type of planes.

(7) Height of planes.

An example of telling is: Target 13, red, 72 Klaxen 31, North, three, bimotor, high; meaning that the target number is 13, that a red arrow pointing north has been placed at 72 Klaxen

31, and that there are three bimotor planes flying high. For complete operation instructions, refer to paragraph 106.

■ 90. RADAR BOARD PLOTTERS.—*a. General.*—Radar or radar board plotters are provided at the radar boards to plot information on these boards as received from the radar stations.

b. Telephone equipment.—Each radar plotter position has a telephone headset, lamp, and one-way lever key and a single push-button ringing key. To occupy position, connect headset to jacks and operate lever key. To answer call, no further action is required if lever key is kept in operated position. Incoming calls are indicated by a lighted lamp and momentary tone heard in the receiver. To originate a call, make sure that the lever key is in the operated position; ring on push-button key for about a second.

c. Plotting equipment, radar plotter.—When a call is received, the plotter answers with "Go ahead, please." He removes a magnetized arrow of color indicated by clock color code, and places the magnetized arrow on the grid location told him on the vertical radar board. He points the arrow in the direction indicated by the succeeding plot. It is possible that another radar plotter at his board will be receiving plots from another radar station on the same flight. If so, he checks his plots with those of the other, and arrives at the one course which seems to be correct. The raid clerk will assign target numbers to the flights appearing on the radar board. The plotter places the target number card as designated by the raid clerk under the magnet of one of the leading arrows of the particular flight. Tracks of flights shown on the radar board should be so marked as to establish which unit is reporting the flight in question.

■ 91. RADAR TELLER TO FILTER BOARD.—*a. General.*—The radar teller to filter board tells radar board plots to the filter board when they are inside the 20-mile seaward overlap area of the radar board in order that the flight, as it approaches the shore, will appear on the filter board.

b. Telephone equipment of radar teller.—The radar teller to filter board has telephone equipment which includes one-way lever key, nonlocking push-button keys with designation strip, and telephone headset. To originate a call, operate

the lever key and hold depressed the key associated with the line to the plotter in the correct area, as indicated on the designation strip.

c. Information to be told by radar teller.—The land area of the radar board has marked on the board a 20-mile overlap into the sea. Each plot, either over the land or in the seaward overlap area, will be told to the filter board over whose area on the radar board the flight is appearing. The color of the arrow, direction of flight, grid location of the tail of the arrow (grid system explained in par. 68) and the target number will be told.

d. Sequence of telling.—In order that the filter board plotter will know that he is receiving a plot from radar teller, the radar teller will first say, "Radio overlap," and state—

- (1) Color of arrow.
- (2) Grid location.
- (3) Direction of flight.
- (4) Last target number, if known.

Example: Radio overlap, red, 72 Klaxen 31, west 6.

■ 92. RADAR BOARD TELLERS TO INTERCEPTOR BOARD.—*a. General.*—For each interceptor board, there is, at the radar board, one radar board teller available, who is connected directly by telephone with the intercept board plotter.

b. Telephone equipment.—The teller's telephone equipment consists of a one-way lever key and telephone headset. When the position is occupied, the lever key is operated. No further action is necessary to answer or originate calls.

c. Information to be told to intercept board plotter.—The intercept board will notify the teller of a particular target number that he wants followed. The teller tells information concerning each new plot of the target appearing on the radar board. This will include the color of the arrow, grid location of the tail of the arrow, and direction of flight.

d. Sequence of telling to intercept board plotter.

- Target number.
- Color of arrow.
- Grid location.
- Direction of flight.

■ 93. OPERATIONS OF PATCHING SWITCHBOARD.—*a. General.*—The training and patching switchboard is used by the wire chief to make normal connections, to make emergency connections in the case of failures in equipment, to make connections for training purposes, and for use in handling calls under emergency conditions.

b. Telephone equipment for patching switchboard.—Private lines and toll lines terminate at the training and patching cord switchboard, and from there are connected to positions at the filter board or information center. The operation of this equipment is as follows:

(1) *For normal operation.*—For lines which have four jacks (regular, training, answering, and transfer) connect the two upper jacks (regular and training) with a patching cord, and insert a dummy plug in the lowest (transfer) jack. For lines which have three jacks (alternate, regular, and training) connect the two lower jacks (regular and training) with a patching cord. For lines which have two jacks (regular and training) connect the two jacks with a patching cord.

(2) *For emergency in case of failure of circuits.*—For lines which have a particular alternate circuit specifically assigned (those having three jacks), connect the upper (alternate) jack and the lower (training) jack with a patching cord. For lines which do not have a particular alternate circuit specifically assigned (those having two jacks), connect the lower (training) jack to the jack of one of the miscellaneous alternate circuits (those having one jack) with a patching cord. For the private line circuits (those having four jacks), no alternate circuits are provided.

(3) *For training, switchboard patching.*—When it is desired to train an attendant at a certain position, select the proper circuit, disconnect the lower end of the patching cord, and insert the front cord of a P. B. X. cord pair in the same jack (training). Then connect the other cord of that pair to the P. B. X. station of the instructor.

(4) *Patching for handling calls, patching switchboard.*—When a position at which a private line circuit is normally answered is vacated, the dummy plug may be removed from the lowest (transfer) jack, and any incoming calls will then light the associated answering lamp. They may be answered by connecting a front cord to the second jack from the

bottom (answering). It is also possible to ring on a private line, if necessary, by removing the dummy plug and connecting a back cord for about 1 second. Occasional calls received over the other types of lines will light the associated lamp, and may be answered with a front cord.

■ 94. ADMINISTRATIVE P. B. X. OPERATION.—*a. General.*—On all calls other than those from extension to extension, the operator must ask if the call is personal or official. Use the phrase, "Is this an official call?" If the call is not official, tell the extension user to make his call from a public telephone booth. On all official calls, other than extension to extension, request the name of the extension user, and write on a ticket the extension number, name of the calling person, and the number called. In all cases, the operator must complete the connection. Do not let the extension user himself pass his call to the commercial central office operator.

b. Operation of telephone equipment, P. B. X. operation.—

(1) To answer an extension, plug in with a cord in back row (farther from operator). To answer a central office line (called trunk), plug in with a cord in front row (nearer operator). To listen or talk, push back the front key in line with the cord pair used. To establish connection to an extension, plug into the called line with the other cord of pair to answer, then ring on that cord. To ring on the front cord, pull forward the front key in line with the cord pair used. To ring on the back cord, pull forward the back key in line with the cord pair used.

(2) To establish a connection to the dial central office, have a front key pushed back, plug into the trunk, and when you hear the dial tone, restore the key. To establish a connection to a manual central office, plug into an idle trunk with the front cord of the pair used; to answer, have the front key pushed back, and when the operator answers, give the operator the number, then restore the front key.

(3) When transferring a central office connection from one extension to another, have the associated front key pushed back to avoid losing connection with the central office. When back and front cord lamps of a pair are both lighted, take down the associated cords. In a dial office, restore the back key to normal if operated. If the back or front cord lamp lights or flashes after it has gone out on

answer, push back the associated front key and speak, then proceed as requested. If no response is received, take down the associated cord or cords.

(4) When the switchboard is unattended, turn key marked **BATTERY** to **OFF** position.

(5) To ring with the hand generator, turn the key marked **BATTERY** to **OFF** position, turn the crank while holding the proper front or back in ringing position. Use the hand generator only when normal ringing current is not available.

SECTION II

DUTIES OF INFORMATION AND FILTER CENTER PERSONNEL

■ 95. **GENERAL.**—The personnel who have tactical functions in an information center are located on a control platform and in the intercept room. This section describes the tactical functions which are carried on within an information center. Some of these functions may be decentralized to filter centers, but the functional procedure remains the same.

■ 96. **RAID CLERK.**—*a. General.*—The raid clerk is located at a desk on the floor of the operations room. He will have one or more helpers or clerks. He has two primary functions: first, he assigns a raid number to each new raid that appears in the region, and keeps a raid number assignment sheet (see Form No. 6, appendix); second, the raid clerk is in charge of the process (for the controller) of identification of the origin of the raid in question.

b. Telephone equipment.—The raid clerk is provided with the following telephone equipment at his desk: a cabinet with keys, and a handset and buzzer for communication with the controller, radar officer, antiaircraft artillery officer, support command liaison, bomber command liaison, Navy liaison, Army liaison, and Civil Aeronautics Administration liaison. To answer an incoming call when the answering (white) lamp lights and the buzzer sounds, operate the key associated with the lighted lamp to the talking (first) position and lift the receiver. To originate a call, lift the receiver and operate the key associated with the desired line (as indicated on the designation strip) to the talking (first) position. To dis-

connect, restore the key to normal and restore the receiver. Two or more lines may be bridged together for a conference on incoming or outgoing calls by operating the key of each such line to the talking position. There is also a six-button key and handset for communication with plane position plotters at the intercept boards. To listen in on a line, depress the associated key and lift the receiver. No answering lamps are provided, since these lines are used for outgoing calls only. No facilities are provided for ringing on these lines, since they are generally in constant use. Should it be necessary to ring, the raid clerk may request the radar operator to ring on the desired line. There is also a six-button key set with lamps, a handset, and a buzzer for talking with the controller, administrative P. B. X., and floor supervisors at operations and filter boards. To answer an incoming call when the answering lamp lights and buzzer sounds, depress the key associated with the lighted lamp and lift the receiver. Incoming calls from the administrative P. B. X. are indicated by the telephone bell, and are answered by depressing the key associated with the P. B. X. line and lifting the receiver. To originate a call, depress the key associated with the desired line and lift the receiver. To disconnect, restore the receiver.

c. Other equipment.—The following additional equipment is used:

(1) A red colored spotlight to indicate on operations and radar boards from the raid clerk's position.

(2) Raid log notebook.

(3) Raid number box, containing one set of red plastics, one set of green plastics numbered from 1 to 99, and a set of yellow plastics, 10 each of B, X, O, R, N, and T.

d. Duties of raid clerk.—(1) The raid clerk will maintain a constant watch of the operations board. When a new flight appears on either the operations board or the radar board, a target number is assigned to it. This number cannot be a duplication of any other raid number that may be on the boards. The clerk either places the raid number on the stand himself, or by phone directs that the correct number be placed on the stand by the plotter. If flight is definitely identified as friendly, and traffic is heavy on the board, friendly flights over land need not be assigned a target

number. All radar flights will be numbered. The assignment of target numbers under the above option will be at the discretion of the controller.

(2) When a target comes on the board from any adjoining region, a blue clip will be fixed to the top of the red or green (enemy or friendly) card. The raid number will be the one that was assigned by the other region. As soon as it is established that this raid will remain in the raid clerk's region, and that the controller wishes that the target be plotted, the raid clerk will remove the target number and blue clip of the other region, assign a free number belonging to his region, and make a note showing the other region number in the target assignment list. If the number of the target assigned in the other region is free in the region in question, that number should be left on the target, and the correct entry made on the target number sheet.

(3) When a new target appears on the board, and after the target number has been assigned, the identity of the target must be determined. This determination is of primary importance to the controller, and may or may not be a difficult problem. This problem will be solved by the following general method: First, upon the order of the controller, or in the absence of the order, the raid clerk will establish a conference circuit between the pursuit officer, the Navy, Army, bomber, and Civil Aeronautics Administration liaison officers, and the radar officer. The controller may or may not join this conference. When the conference is established, the raid clerk advises the conference members of the new target and requests each member to claim the target, if the aircraft of the target indicated belongs to his command. If none of the above officers is able to claim the target, it is then assumed to be enemy and is so marked. Prior to this process, the type of aircraft in the flight is indicated by the yellow type card (IX, IB, IR, or IN) if the type of aircraft has been reported or deduced. The "I" in front of the type designation letter indicates that the report has not been verified. When, and if the type of aircraft is definitely determined, the "I" card is removed, and a one-letter yellow card is placed on the stand. This card indicates that the origin of the target has been absolutely established as belonging to the command designated by the card. It is seen from the

above that the decisions made by the raid clerk are of very great importance to the successful carrying out of the mission of the Air Warning Service, and, therefore, the best type of personnel must be assigned as raid clerks.

(4) When the raid clerk assigns a target number, indicates the type of aircraft, or makes any change on the target display stand, he will call the floor supervisor of the filter board on which the raid appears, and advise him of the above changes in order that the filter board may correctly label the raid in question. A "U" designator card will be placed on the top of any stand for which the identity of the raid is in doubt. This does not change the use of the red enemy card.

■ 97. CONTROLLER.—*a. Authority.*—The controller is the representative of the interceptor commander, and he is the tactical commander of the region during his tour of duty. The forces under his command are composed of assigned or attached intercept pursuit aviation, antiaircraft artillery, searchlights, automatic weapons, and barrage balloons. The controller also exercises tactical control of the operation of all other antiaircraft units that may be in the region other than those assigned to army corps actually in contact with the enemy. He also exercises tactical control of all parts of the Aircraft Warning Service. The controller's staff consists of the personnel on the control platform of the information center and the regional signal officer. The duties performed for the controller by members of this staff will be described in paragraphs 98 to 111, inclusive, for each officer.

b. Location of controller.—The controller is located at the center of the platform (see fig. 13) overlooking the operations room. In front and to one side of the controller's position is mounted a telephone switchboard which permits the controller to get telephone communication to all necessary locations in his region, as well as the necessary positions in the information center. It is possible for the controller and the pursuit officer to reach the following places or persons through his telephone switchboard:

- (1) All control airdromes in the region.
- (2) All intercept officers.

- (3) All control personnel on the platform.
- (4) Raid clerk.
- (5) Status board.
- (6) Floor supervisor in the operations room.
- (7) Floor supervisor in the filter room.
- (8) Controllers in adjacent regions.
- (9) Other filter rooms in the region.
- (10) Administrative P. B. X. board.
- (11) Any radio station in the region and to go on the air over these stations.
- (12) Message center chief.
- (13) Weather officer.
- (14) Interceptor commander. (This line is not to be used except in the case of emergency.)

(15) The controller is also able to have a conference circuit set up for him by any liaison officer, which will allow any or all of the following people to confer: controller, pursuit officer, bomber, Navy, Army, Civil Aeronautics Administration, raid clerk, and the radar officer. This conference circuit is normally used in the process of identifying tracks on the board in order to determine whether they are friend or enemy, and if friendly to which command they belong.

c. Controller's switchboards.—The controller's switchboards are operated in the following manner:

(1) *Handset and key equipment.*—This equipment is located in front of the position, and connects to other information and filter centers and to other positions. To answer an incoming call, when the buzzer sounds, operate the key in the same vertical row as the light toward the lighted lamp and lift the receiver. When desired, the buzzer may be made inoperative by turning the buzzer control key in the upper right-hand corner to the OFF position. To originate a call operate the key toward the desired line as indicated on the designation strip and lift the receiver. Ring by operating the extreme right-hand lever key (white) downward for about 1 second. When a line which has a colored designation strip is to be used, do not ring; throw the key and talk. If no answer is received, then use the ringing key to summon the operator to "answer" position. To disconnect, restore the key to normal and restore the handset. To have a conference with bomber, Navy, Army, Civil Aeronautics Admin-

istration, radar officer, and raid clerk, call any one of these and have him set up conference on his equipment. In some cases, the *busy* (green) lamps will be operative. If the line is in use, a green lamp will be lighted. The *hold position* of the extreme right-hand key (white) is ineffective, and one call cannot be held while the telephone set is connected to another call. When the battery key in the lower right-hand corner is turned to the ON position, all incoming calls are indicated by a steady lamp and buzzer (if connected). When turned to the OFF position, the signals are the same except that on incoming calls over the private line circuits, the lamp and buzzer will operate only during ringing from the distant end.

(2) *Handset with push-to-talk key, and radio channel assignment and busy lamps for circuits to radio switch-board.*—Connection to a particular radio channel is requested of the radio officer, either over a separate telephone line as described above, or by direct request, if located nearby. When the radio officer assigns the channel, the assignment lamp associated with that channel will light. The push-to-talk key on the handset switches the radio circuit from receiving to transmitting, and must be held depressed while transmitting. While the circuit is in the transmitting condition, the busy lamp associated with that channel will be lighted. Any other station desiring to transmit on the same channel at the same time should be governed by the action of the busy lamp.

(3) *Handset to administrative P. B. X.*—The handset to administrative P. B. X. operates as a regular telephone through the P. B. X. board. The location of the handset, key equipment, and buzzer to control airdromes, radio A officer, and pursuit interception officer is to one side of the controller's position. To answer an incoming call, the answering (white) lamp lights and the buzzer sounds, operate the key associated with the lighted lamp to the talking (first) position and lift the receiver. To originate a call, lift the receiver and operate the key associated with the desired line (as indicated on the designation strip) to the talking (first) position. It is necessary to ring only if there is no answer to the call. To ring, hold the associated key in the ring (second) position for about 1 second. To disconnect,

restore the key to normal and restore the handset. Simultaneous communications may be established to one control airdrome, one pursuit intercept officer, and the radio A officer by operating these three keys. Two control airdromes or two pursuit intercept officers should not be connected simultaneously.

■ 98. GENERAL MISSION ASSIGNED TO CONTROLLER.—*a.* The general mission assigned to a controller is the defense of a given air space (that space over his region) against enemy aircraft. The combat effectiveness of the active defense weapons in air defense is a function of the timeliness, accuracy, completeness, and continuity of intelligence of enemy air movements. This information comes from the Aircraft Warning Service, and is presented to the controller as a picture on the operations board. The regional signal officer is charged with the operation of this service. The original tactical disposition of the active defense forces in a region is made by the interceptor commander based upon the results of the air defense study and plan for the region in question. As described above, the controller has all the necessary elements of information to make his tactical decisions for the employment of the active forces. He is also provided with the means of issuing his orders, based upon his decision, to carry out his mission. The tactical decision is made by the controller, after a brief estimate of the situation, based on enemy intelligence supplied by the Aircraft Warning Service, and other G-2 information of the enemy. This information is considered in the light of the assigned mission; the relative combat strength of his own and the enemy forces; the enemy's capabilities based on his disposition, his strength, type of aircraft; and the possible targets in the area. The various plans of action open to the active forces of the air defense are considered, and the decision is made to use the plan most likely to succeed in the particular situation presented.

b. The controller, in a region where the Aircraft Warning Service is secured primarily by radar, must decide the altitude or amount of vertical interval that pursuit must search for the target. The amount of vertical interval to be searched will modify the controller's decision relative to the amount of pursuit which must be dispatched.

■ 99. **PURSUIT OFFICER.**—The pursuit officer is the assistant controller; he is second in command, tactically, of the region. This officer is supplied with a duplicate of the controller's telephone switchboard. (See par. 97.) The pursuit officer will be able to perform all the functions of the controller. In addition to the above, when the pursuit officer is functioning as pursuit officer, he is directly charged with the following duties:

a. He keeps himself continually informed as to the status of all the active forces in the region.

b. He chooses the unit or units from an airdrome to be ordered on the mission, after being directed to do so by the controller. That is, the controller may say to the pursuit officer, "Intercept target five from Suffolk with two flights." The pursuit officer then chooses the two flights for the mission. The choice of the correct flights will be based on availability, readiness, the number of missions already performed, and by the state of training of the flight commanders in the light of the mission to be performed.

c. He is charged with making sure that the status board is correct and kept up to date.

d. If, when a mission is decided upon, it is necessary immediately to order the intercepting force into the air, the pursuit officer will, before assigning the mission to an intercept board, order the unit to take off, give the direction in which the unit is to fly, and the altitude to be gained. When this is done, he chooses an available intercept board and gives the mission to the intercept officer at that board. The pursuit officer also calls the radio A officer, advises him of the mission that is starting, and orders that the necessary air-ground radio channels be set up for the use of the intercept officer. The pursuit officer also controls the state of status of the units at airdrome for, or on the order of, the controller.

■ 100. **RADIO A OFFICER.**—*a. Duties.*—The radio A officer is located on the control platform next to the pursuit officer in a noiseproof cabin. He is charged with maintaining continuous two-way contact with the intercept forces in flight. He is provided with a switchboard which allows him to connect the intercept officers to any of the radio stations in the region. The radio A officer is in charge of all air-ground radio com-

munication in the region. He will obtain a map of the region, and on this map will spot the locations of each radio station. Around these locations, he will indicate the area in which communication can be had with aircraft from the radio in question. Knowing this, and by monitoring on the circuits when in use, he can, by switching to correct station locations, keep the intercept officer in communication with the flight or flights which the intercept officer is directing.

b. Telephone channels.—The radio A officer is provided telephone channels to the following places:

- (1) Radio channels.
- (2) Intercept officers.
- (3) Pursuit officer's and controller's positions.
- (4) Clerks at intercept board.
- (5) Controller.
- (6) Administration P. B. X.
- (7) Miscellaneous lines.

c. Telephone equipment.—The method of operating the equipment is as follows:

(1) The radio A officer is provided with key cabinet, desk stand telephone with push-to-talk key, head-band receiver, and radio-channel busy lamps. The radio channels terminate in horizontal rows, and stations terminate in vertical columns. To connect a particular station to a particular channel, operate the key which is common to the row and column concerned. The radio A officer's own station (desk stand) is associated with the left-hand column. To answer an incoming call on the radio channel, operate the left-hand key in the same horizontal row with the lighted answering lamp. To originate a call on a radio channel, if the desired channel is idle (no keys operated in that horizontal row), operate the left hand key and depress push-to-talk key. To disconnect, restore the key. The push-to-talk key on the desk stand switches the radio circuit from receiving to transmitting, and must be held depressed while transmitting. While the circuit is in the transmitting condition, the busy lamp associated with that channel will be lighted. One or more stations may be connected to a single radio channel, but not more than two channels should be connected to one station. Any other station desiring to transmit on the same channel at the same

time should be governed by the action of the busy lamp.

(2) At the radio A officer's position, there is also a button key set with lamps, handset, and buzzer for communication with clerks at the intercept board. To answer an incoming call, when the answering lamp lights and buzzer sounds, depress the key associated with the lighted lamp and lift the receiver. To originate a call, depress the key associated with the desired line and lift the receiver. To disconnect, restore the receiver.

(3) The button key set with lamps, handset, and buzzer for communication with the controller, administrative P. B. X., and miscellaneous lines will be used as follows: To answer an incoming call, when the answering lamp lights and buzzer sounds, depress the key associated with the lighted lamp and lift the receiver. Incoming calls from the administrative P. B. X. are indicated by the telephone bell, and are answered by depressing the key associated with the P. B. X. line, and lifting the receiver. To originate a call, depress the key associated with the desired line and lift the receiver. To disconnect, restore the receiver. When necessary, the radio A officer may talk to the remote radio station operator as follows:

(a) If the radio channel is not in operation, and if the channel key is depressed, the radio A officer may talk with the radio operator.

(b) If the radio channel is in operation and on transmit, the radio A officer may not talk with the operator.

(c) If the radio channel is in operation and on receive, the radio A officer, in order to talk with the radio operator without going on the air, will rapidly operate the channel key. This will, by flashing a lamp signal, tell the remote radio operator to turn the transmitter key off. When this has been done, the radio A officer will be able to talk with the remote radio operator without going on the air. The receiver will still be operative in this condition. The radio A officer at each regional information center has a 1,000-cycle test oscillator to be used for testing the quality of the radio-channels lines, and, when used, allows the radio-station operator to adjust his line gain control to the correct amount.

■ 101. RADAR OFFICER.—a. The radar officer is located on the

control platform to one side of the controller. He is charged with the tactical operation of all radar equipment. He will advise the controller on the methods of operation of this equipment so that the controller can receive the type of information needed, at the time needed.

b. The radar officer is provided with a telephone switchboard which gives him telephone connections to the following places:

- (1) Controller.
- (2) Bomber command.
- (3) Navy liaison officer.
- (4) Army liaison officer.
- (5) Civil Aeronautics Administration.
- (6) Raid clerk.
- (7) Radar plotters.
- (8) Radar equipment.
- (9) Administrative P. B. X.

c. The radar officers' switchboard is operated as follows:

(1) To answer incoming call, when the answering (white) lamp lights and buzzer sounds, operate the key associated with the lighted lamp to talking (first) position and lift the receiver. To originate a call, lift the receiver and operate the key associated with the desired line (as indicated on the designation strip) to the talking (first) position. To disconnect, restore the key to normal and restore the receiver. A conference of two or more lines together may be made, either on incoming or outgoing calls, by operating the key of each such line to the talking position.

(2) The radar officer has key equipment, a handset, and buzzer for communication with the controller, administrative P. B. X., and radar locations. This equipment is operated in the following manner: To answer an incoming call, when the answering (white) lamp lights, and the buzzer sounds, operate the key in the same vertical row toward the lighted lamp and lift the receiver. When desired, the buzzer may be made inoperative by turning the buzzer-control key in the upper right hand corner to the OFF position. Incoming calls from the administrative P. B. X. are indicated by the telephone bell, and are answered by operating the key toward the P. B. X. line as indicated on the designation strip and lifting the receiver. To originate a call, operate the key in the same

vertical row toward the desired line as indicated on the designation strip and lift the receiver. To ring on a line, operate the extreme right-hand lever key (white) downward for about 1 second. Private lines that are continuously manned will be indicated in color on the designation strip. Ring only on these circuits if you receive no answer to a challenge. In some cases, the busy (green) lamps will be operative. If so, a green lamp will be lighted while the associated line is in use either on an incoming or outgoing call. The **HOLD** position of the extreme right-hand key (white) is ineffective, and one call cannot be held while the telephone set is connected to another call. When the battery key in the lower right-hand corner is turned to the **ON** position, all incoming calls are indicated by a steady lamp and buzzer (if connected). When turned to the **OFF** position, the signals are the same, except that on incoming calls over the private line circuits, the lamp and buzzer will operate only during ringing from the distant end. The above does not apply to calls from the administrative P. B. X.

■ 102. CIVIL AIR RAID OFFICER.—*a.* The civil air raid officer will be on duty on the platform overlooking the operations board at information centers and filter centers. Under this officer, there is also on duty at all times a switchboard operator for the special civil air raid warning switchboard.

b. The equipment provided includes a special map known as the "memory board," a raid warning template, and a telephone. The memory board is a map of the region or filter area, provided with a translucent surface, so arranged that colored lights, yellow, blue, red, and white, indicate the state of raid warning which has been given to each of the raid control districts into which the area is divided. These lights are automatically controlled by connections from the civil air raid warning switchboard. Four degrees of warning are provided as follows:

(1) *Yellow message.*—This is a preliminary caution sent to a district as soon as there is any possibility of a raid in the district. This is a confidential message intended for transmission by civil authorities to a limited number of recipients who take unobtrusive precautionary measures in order to be ready to act instantly when a blue or red warning message is received.

(2) *Blue message*.—This is the second degree of caution transmitted when the objective of the raiders is determined. This message usually has the same distribution as the yellow message, and is also confidential. At night, it is a light warning for railroads, essential industries, and highway officials to put out or dim lights in accordance with pre-arranged plans for a blackout.

(3) *Red message*.—This is the action warning sent when the possibility of a raid becomes imminent. This is a warning message to the public, and after its receipt at the various control centers, it is relayed to the public by audible warning signals such as sirens or power whistles.

(4) *White message*.—This is the "all clear" message sent after raiders have either passed from a district or all danger of a further raid is over for the time being. This message is sent to all recipients of the other messages, except that it is not relayed to the public unless a previous red message is still in force.

c. It is the duty of the civil air raid officer to determine the degree of alarm, the control centers to which issued, the time, and to make certain that the appropriate message is promptly transmitted to and acknowledged by the chief warden or controller at each control center.

d. The principal aid to the civil air raid officer in arriving at his decision is the warning template, which is a transparent guide, to the same scale as his map, with yellow, blue, and red curves. When superimposed on present position and course of an enemy air attack, these curves will indicate probable points which the enemy might be expected to reach after so many minutes of flight (based, for present purposes, on 20, 12, and 5 minutes' straight flight at 300 miles per hour for yellow, blue, and red, respectively). It should be especially noted that after the raid has passed, any degree of warning which has been given is retained until the white "all clear" signal may safely be given. The progression is thus from yellow to blue or white only; from blue, either to red or to white, never to yellow; and from red only to white. The template is used as a guide only. Judgment and experience will indicate a broader basis for the issuance of warnings.

e. When the civil air raid officer transmits an air raid

warning signal, the local toll operators repeat the orders as received. The toll operators ring the warden for that district, and also light the appropriate colored signal on the warden's desk. The civil official acknowledges both verbally and by pressing a colored button. His acknowledgment is received in the information center by the switchboard attendant, who then replaces the talking cards with "memory plugs" in the jacks marked according to the color of warning given. When either the cord or the memory plug is in any jack on the switchboard, the corresponding colored light of the civil air raid warning map glows.

f. The foregoing procedure is illustrative of that used by the civil air raid officer at any filter center for raid warnings within his own filter area. In addition, it is necessary to provide for warnings in a wide overlap area surrounding each region. The civil air raid officer at the regional information center is charged with this responsibility, covering initially a belt 100 miles wide surrounding the region. For any raid over his own region, he will determine the need for warning control centers in adjacent regions, and will transmit such warnings over lines to be provided to the civil air raid warden switchboard in the filter center concerned.

■ 102. ANTI-AIRCRAFT OFFICER.—*a. Duties.*—The anti-aircraft officer will maintain at all times an accurate up-to-date record of the location of all anti-aircraft artillery, searchlights, and barrage balloons in the region. He will be prepared to advise the regional commander concerning any changes in the above locations necessitated by the situation. The anti-aircraft officer will observe any hostile air activity as shown on the operations board which might affect the anti-aircraft artillery, searchlights, or balloon barrage, and will transmit information of such activity promptly to local air-defense forces concerned. He will require the anti-aircraft artillery information service to report to him promptly any enemy information, will analyze such information, and pass to the controller any data deemed relevant and not already known to that official. He will transmit to the anti-aircraft artillery, searchlights, and balloon barrage any orders of the controller affecting them. When the controller delegates to him the authority for such action, he

will determine from a study of the situation the advisability of ordering antiaircraft fire withheld, barrage balloons lowered, and searchlights kept out of action, and will issue such orders.

b. Telephone equipment.—The antiaircraft artillery officer has telephone connections to the following places or persons: the administrative P. B. X., the controller, support command, bomber command, Navy and Army liaison officers, Civil Aeronautics Administration, and the raid clerk. The antiaircraft officer also has telephone communication to the antiaircraft stations. The telephone equipment is operated in the following manner:

(1) The antiaircraft officer has a cabinet with key equipment, a handset and buzzer for communication. To answer an incoming call, when the answering (white) lamp lights and buzzer sounds, operate the key associated with the lighted lamp to the talking (first) position and lift the receiver. To originate a call, lift the receiver and operate the key associated with the desired line (as indicated on the designation strip) to the talking (first) position. To disconnect, restore the key to normal and restore the receiver. Two or more lines may be bridged together for a conference either on incoming or outgoing calls, by operating the key of each such line to the talking position.

(2) Key equipment, lamps, handset, buzzer, and white beehive lamp for communication with the controller and antiaircraft stations. To answer an incoming call, when the answering (white) lamp lights and the buzzer sounds, operate the key in the same vertical row toward the lighted lamp and lift receiver. When desired, the buzzer may be made inoperative by turning the buzzer control key in the upper right-hand corner to the OFF position. Incoming calls from the controller are indicated by lighting of the white beehive lamp, and are answered by merely lifting the receiver. If there is an incoming call from the controller while the handset is in use on another call, the beehive lamp will not light, and the controller will immediately be connected. To originate a call, operate the key in the same vertical row toward the desired line as indicated on the designation strip and lift the receiver. Ring by operating the extreme right-hand (white) lever key downward for about 1 second. The HOLD

position of the extreme right-hand key (white) is ineffective, and one call cannot be held while the telephone set is connected to another call. When the battery key in the lower right-hand corner is turned to the ON position, all incoming calls are indicated by a steady lamp and buzzer (if connected). When turned to the OFF position, the signals are the same except that on incoming calls over the private line circuits, the lamp and buzzer will operate only during ringing from the distant end. Handset for communication with the administrative P. B. X. operates as a regular extension.

■ 104. **LIAISON OFFICERS.**—*a. Duties.*—The liaison officers are located around the platform in positions which allow them to see the information with which they are concerned. These officers represent the Army and air support, the Navy, the bomber command, and the Civil Aeronautics Authority. They are charged with supplying the controller with all the information that the controller may want or need to aid him in making his decisions relative to the branch represented by the liaison officer. They also relay to their respective headquarters or activity all orders, instructions, or suggestions issued by the controller that apply to them. In addition to the above, one of the most important functions of these officers is to aid the controller and raid clerk in identifying the aircraft in any flight that appears on the board. This identification is made in two main categories, friendly or enemy. If the flight is friendly, then it must be determined to what organization the aircraft belong. In order to do this, each of the above officers must know the disposition of all the aircraft in the air from his command.

b. Telephone equipment.—The liaison officers are provided with telephone for communication with the controller, radar officer, anti-aircraft artillery officer, raid clerk, and other liaison officers. The telephone equipment operates as explained in paragraph 96b. Check designation strip carefully before originating call.

■ 105. **WEATHER OFFICER.**—Each region will have a weather officer located at the information center. Each information center will have a weather teletypewriter connected to a weather channel for up-to-date weather. The weather officer will be charged with making 6-hour forecasts for

future weather conditions within his region, and also charged with supplying the controller with an hourly map showing the present flying conditions within the region. This map will be an outline map of the region upon which the present weather conditions will be plotted with cross hatching and superimposed letters to indicate type of weather to be found over the area.

■ 106. OPERATION OF INTERCEPT BOARD.—*a. General.*—Around the intercept board (see fig. 13) are located an intercept officer, enemy plotter, friendly plotter, and a clerk.

b. Telephone equipment.—The enemy plotter has a six-button key set with associated lamps, one-way lever key, and headset for communication with radar tellers and intercept tellers. To answer an incoming call, when the answering lamp lights, depress the associated key and operate the lever key. Use the phrase "Go ahead" when answering. The friendly plotter has a six-button key set with associated lamps, one-way lever key, and telephone headset for communication with plane position tellers at airdromes. Operation of the equipment is the same as that of the enemy plotter. The clerk has a six-button key set with associated lamps, telephone handset, and buzzer for communication with radio A officer, status plotter, administrative P. B. X., and intercept teller or secondary filter board teller. To answer an incoming call, when the answering lamp lights and buzzer sounds, depress the key associated with the lighted lamp and lift the receiver. Incoming calls from the administrative P. B. X. are indicated by the telephone bell, and are answered by depressing the key associated with the P. B. X. line and lifting the receiver. To originate a call, operate as instructed in paragraph 96b. The intercept officer has a six-button key set, one-way lever key, beehive lamp, and handset for communication with the controller, pursuit officer, and the airdromes. Normally, the intercept clerk will use this equipment for the intercept officer. To answer incoming calls from the controller or pursuit officer, when the beehive lamp lights, lift the receiver. To establish connection to the airdrome, depress the proper push-button key and then operate the lever key. To disconnect from the airdrome, restore the lever key and restore handset.

c. Duties of the intercept board personnel.—(1) The enemy plotter will receive the order to plot a given target from the intercept officer. The intercept officer will designate the target to be plotted by giving the target number. The plotter will then call the intercept tellers associated with his board, and order them to tell plotted target information regarding the designated enemy target. He then plots on the intercept map overlay all the information told him about the target he called for. The plotter will note the time he receives the first few plots so as to make it possible to make an early estimation of the enemy's ground speed. These times will also serve as a time base for checking the ground speed later in the problem. This plotter will be ready to predict the enemy's course 15 or 20 minutes ahead of the latest plot when needed by the intercept officer. The plots should be made with red, green, and blue pencil to correspond with the color code as told by the teller. Target information will be noted near the start of the track. (See par. 70.)

(2) The friendly or pursuit plotter is charged with plotting the course of the interceptor pursuit force ordered on the mission assigned to the intercept board in question. This information is received over telephone lines from the airdrome in question.

(3) The intercept officer's clerk is located at a small table near the intercept board. This clerk operates the intercept officer's switchboard, takes all calls for the intercept officer if he is busy, makes a record of all orders transmitted by the intercept officer, and keeps any other records required by the intercept officer. The clerk also listens in on all radio contacts, and makes such notes on the messages received as desired by the intercept officer. He also transmits to the status board any changes of status that occur during the flight. (See par. 42f.)

(4) The intercept officer is in charge of all the men assigned to his intercept board. When the intercept officer is assigned a mission, he is in charge of that flight, subject only to orders from the controller and pursuit officer. The controller and pursuit officer will oversee the operations of the intercept officer, and may take over the flight in question or change any orders issued by the intercept officer at any

time. The intercept officer must at all times have the latest winds aloft for his area, and must have the temperature aloft reported to him when needed. The intercept officer has two primary functions. First, he will plot the course of any enemy raid or raids assigned to his board, and from these be prepared to calculate a course for whatever intercept forces are assigned him in such a manner as to place the intercept force in front of the enemy formation. The intercept force should arrive at such a point 3 minutes ahead of the enemy. Second, the intercept officer is charged with issuing the necessary navigation instructions to the unit in flight to carry out the above via the provided radio channels. He will make every effort possible to reduce to a minimum the length of all radio contacts made. He is also charged with insuring that all personnel at the intercept board pass on information pertaining to other activities.

~~107.~~ STATUS-BOARD PLOTTERS.—*a.* The status-board plotters are charged with keeping the information on the status board up-to-date and correct in order that the information on this board will accurately picture the status of the aircraft and pilots at each operating airdrome in the area. In order to accomplish the above, the status-board plotter is given telephone access to the command telephone line to each airdrome. Over this line he receives the changes in status from the airport where changes of status occur. Status is plotted for the smallest tactical unit stationed at the airdrome. If any part of the element is not available, the whole element is out. At present, the status boards are made up of blackboards which are divided vertically into elements, and horizontally into the status to be recorded (see fig. 14). It is planned to replace these boards with electrical status boards as soon as possible. When the electrical board is used, the status is designated by lighting the light in the correct division of the board. When the blackboard is used, a number will be entered in the appropriate column of the status board to indicate the number of aircraft available in each arrangement. This provision will allow the status board to operate without change for two-, three-, or four-ship arrangement. If a unit is not available, there will be a number in the "not available" column. The unit is reported

as not available if any part of that unit is unable to undertake a combat flight due to lack of reserves or necessary replacements. If an element is reported as available, the number will be placed in the correct available column, and also in the column which correctly describes the element's state of availability; that is, readiness, standby, alert, or stations. When a unit at the airdrome is ordered off, the status-board plotter will be informed by the pursuit officer, and he will mark up the change of status in the correct columns, and remove all other numbers on the status board for that unit.

b. When radio contact has been established with the unit after take-off, the intercept officer's clerk will notify the status-board plotter of this fact, and also of the type of mission. This information is then marked up and the "ordered off" removed. When the unit in question sights the enemy, the intercept clerk will notify the status-board plotter, and it will be so marked up. The "fuel remaining section" will be maintained by the status teller based upon a time schedule provided for each type of aircraft by the pursuit officer. In order to do this the status teller will note the time of each take-off, and fill in the fuel column after the correct amount of time has passed. The "returning to land column" will be filled in on notification of this fact from the intercept clerk. The "servicing" column is filled in on information from the airdrome. (See par. 42f.)

c. The status plotter has key equipment, two-way lever, and telephone headset for communication with plane-position tellers at airdromes, and airdrome command and status lines. To occupy position, connect headset and operate lever key. To answer an incoming call, when the answering (white) lamp lights, operate the key in the same vertical row toward the lighted lamp. To originate a call, operate the key in the same vertical row toward the desired line as indicated on the designation strip. Ring by operating the extreme right-hand lever key (white) downward. As an alternative, the designation strip may be colored to indicate the private line circuits, and the ringing key employed only with such lines. The **HOLD** position of the extreme right-hand key (white) is ineffective, and one call cannot be held while the telephone set is connected to another call. When the battery key in the

lower right-hand corner is turned to the ON position, all incoming calls are indicated by a steady lamp and buzzer (if connected). When turned to the OFF position, the signals are the same except that on incoming calls over the private line circuits, the lamp and buzzer will operate only during ringing from a distant end. The status plotter has push-button keys and designation strip, if lines also appear at the controller and pursuit officer's equipment, for communication with the controller and pursuit officer. To signal the controller, operate the push-button key associated with the line over which the request was received. The status plotter has push-button keys with lamp, headset, and buzzer for communication with intercept officer. To answer an incoming call, when the answering lamp lights and buzzer sounds, depress the key associated with the lighted lamp and lift receiver. To originate a call, depress the key associated with the desired line and lift the receiver. To disconnect, restore the receiver. The status plotter also has a handset connected to the administrative P. B. X. All incoming calls from airdromes will be answered by the status plotter. If the call is for the controller, the plotter will call the controller and notify him of the call.

d. The status teller when located at a filter center will tell all information appearing on the board to the plotter at the information center status board. The tellers located on the status board at information centers who tell to the status board at the interceptor command (command post) will tell only information concerning the following status available, readiness, standby, alert, and on mission. The status board at the command post will have only the above status listed, and only one column per squadron. Status will be entered in units of one flight (two elements), and will be marked up as 1, 2, or 3, meaning first, second, or third flights of the squadron are in the status listed.

e. The status teller has a one-way lever key, lamp, single push-button ringing key, and telephone headset. To occupy position, connect the headset, and operate the lever key. To answer a call, no further action is required if the lever key is kept in the operated position. Incoming calls are indicated by a lighted lamp and a monotone heard in the re-

ceiver. To originate a call, depress push-button key for about 1 second.

■ 108. RESCUE OFFICER.—*a.* The rescue officer will have telephone communication to the controller, Navy, pursuit officer, radio A officer, all intercept boards, all Army Air Forces posts, crash boat houses, and docks.

b. The duties of the rescue officer are to observe raids so that, if over water, crash boats and rescue boats may be dispatched to the vicinity of the air battle, and to coordinate the rescue activities with the necessary authorities, both civil and military.

■ 109. REGIONAL SIGNAL OFFICER.—The regional signal officer is a staff officer of the regional commander. He is responsible for all plotting operations and administration of the information center. He is responsible for the operation of all communication within the region, except the organic communication of pursuit aviation and antiaircraft artillery.

■ 110. BOMBER COMMAND LIAISON OFFICER.—This officer is located on the platform or balcony. This officer's duties are to identify all bombardment flights in the area, and to supply to his commander any other information needed from the interceptor headquarters.

■ 111. FEDERAL COMMUNICATIONS COMMISSION LIAISON OFFICER.—This officer will have direct communication with a controlling point for all civilian radio stations in the region, and will be able to close them down at any time necessary to prevent the use of the carrier beam as a "homing" aid by the enemy. This officer will also aid in setting up emergency communications in case of failures at any time.

APPENDIX

MODEL FORMS

■ 1. FORM No. 1 (FLASH MESSAGE FORM).—Call your telephone central and say, "Army flash ————" (give your phone number). Central will connect you with an Army information center. When you hear, "Army, go ahead, please," you say, "Flash," and continue message you have checked on form below, in the order indicated.

AIRCRAFT WARNING SERVICE

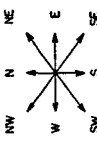
1	2	3	4	5	6	7	8
Number of airplanes	Type of airplanes	Altitude of airplanes	Were airplanes seen or heard	Your observation post code name	Direction of airplanes from observation post	Distance of airplanes from observation post	Airplanes headed toward
3 (Number) Few Many	Single-motor <u>Bimotor</u> Multimotor	<u>Very low</u> Low High Very high Unknown	Seen <u>Heard</u>	Dudley 20	NW N NE W E SW S SE If airplanes were directly over observation post cover columns 6 and 7 by reporting OVERHEAD	2 (Miles)	 Omit if it will cause delay in report.

■ 2. FORM NO. 2 (REPORT OF OBSERVATION POST ORGANIZERS).—

a. Please fill in this form and mark exact location of observation post on section of map attached. Return two copies of this form with marked map to regional commander in the franked envelope provided; no postage is required.

b. The telephone subscriber listed below has volunteered to permit the use of the telephone at the observation post selected, for the reporting of Government collect flash messages. This telephone will be available to authorized observers continuously, day and night, during periods of operation of the Aircraft Warning Service.

 (Name of subscriber)

(Exchange and telephone number)

(Address)

(1) State location of telephone in the house, that is, in the living room, kitchen, bedroom, etc.

 (2) State location of observation post in reference to the house, that is, in the yard, atop the house, on a hill, etc.

 (3) How long, in seconds, does it require to reach the telephone from the observation post?

c. The person whose name appears below has volunteered to act as chief observer for the observation post covered by this report; has been furnished a copy of instructions for chief observers; and agrees to make every effort to comply with the provisions of those instructions:

 (Chief observer's name)

(Telephone number)

(Address)

d. The persons whose names appear below have volunteered to act as assistant chief observers; to assist the chief observer in carrying out the provisions of instructions for

AIRCRAFT WARNING SERVICE

chief observers; and to assume the duties of chief observer in the event that the chief observer is unable to act.

(1st asst chief observer)

(Telephone, if any)

(Address)

(2d asst chief observer)

(Telephone, if any)

(Address)

(Name of person making report)

(Telephone, if any)

(Address)

■ 3. FORM NO. 3 (INSTRUCTIONS FOR CHIEF OBSERVERS).—*a. Duties.*—The chief observer is responsible for—

(1) *Selection of observers.*—Observers may be either male or female. In many cases, female observers will be more readily available than suitable male observers. Male observers should, if practicable, be over 35 or under 18 years of age, and should be chosen from those who are not expected to be called to military service. All observers must be able to speak English clearly and distinctly, so that they can telephone flash messages without difficulty or misunderstanding. All observers selected should have good eyesight for detection of airplanes. It has been learned that blind persons are well adapted to assist observers because of their well-developed hearing and sensing faculties. Many societies for the blind have appealed to the air defense commander to afford such opportunities for service. It is hoped that an opportunity to serve will be accorded to the blind who live near the observation post.

(2) *Continuous manning of observation post.*—The chief observer should obtain enough observers to man the observation post continuously during any period of active air operations without undue hardship on any individual: This can be done by arranging watches or shifts with a definite period of observation duty for each observer. It is also advisable to secure one or more alternate or emergency observers who are

not assigned a watch, but who are available to serve in place of any observer who cannot stand the scheduled watch. The exact length of each watch, the number of watches, the number of observers on each watch, and the total number of observers can be determined only by each chief observer, who is thoroughly familiar with local conditions. In general, a 2- or 3-hour watch is considered reasonable for the period between 10:00 PM and 6:00 AM, and a 4- to 6-hour watch for other periods.

(3) *Instruction of observers.*—Each observer should be fully familiar with instructions for observers and with the flash message form, before engaging in observation duty. The chief observer should test each observer to insure a complete understanding of the procedure of telephoning flash messages and using the flash message form. By acting as the telephone control operator and then as the operator at Army information center, the chief observer may examine each observer and insure complete understanding of the correct form and procedure. This should be done before the observer goes on any observation duty.

(4) *Supervision of operations at observation post.*—It is not necessary that a chief or assistant chief observer remain at the observation post throughout the hours of scheduled air operations. The chief observer is responsible for all operations pertaining to the Aircraft Warning Service at the observation post, and should visit the observation post often enough to see that all is well.

(5) *Records.*—At the observation post should be kept the chief observer's folder in which are filed the following records:

Duplicate copy of Form No. 2 (Report of Observation Post Organizers).

Duplicate copy of Form No. 4 (Report of Chief Observers).

Several War Department penalty envelopes.

At least one copy of Form No. 3 (Instructions for Chief Observers).

At least one copy of Form No. 5 (Instructions for Observers).

A complete list of observers and how they can be reached.

(6) *Initial report of chief observer.*—The chief observer should complete Form No. 4 and mail that report as soon as possible in one of the War Department penalty envelopes provided to the regional commander. Postage stamps are not required on these envelopes.

b. Procedure.—(1) An Aircraft Warning Service is an essential part of air defense. From the timely and accurate reporting of the volunteer observer corps, it will be possible for our pursuit aviation to locate and intercept enemy aircraft. The observer service offers an opportunity for those who cannot actively participate in military operations to do important work for the national defense.

(2) Each observation post should be organized with personnel drawn from the immediate vicinity in order that there will be a minimum of personal inconvenience and no personal expense incurred. The flash messages used in reporting airplanes will be charged to the Federal Government as Government collect telephone calls. There are no funds available for special equipment or facilities or for services. For the initial organization and operation, the air defense requirements must be met by the patriotic volunteers who can provide their telephones, premises, and services to this essential Aircraft Warning Service.

(3) The procedure to be followed by the chief observer in accomplishing the tasks with which he is charged is entirely a matter for him to decide. The suggestions offered below may be inapplicable in many cases, but are made in an attempt to assist the chief observer to obtain the quickest and best results.

c. Initial organization.—(1) Get the necessary number of volunteer observers and appoint your assistants. Frequently, this can be done by arranging with some local organization—fraternal lodge, business men's luncheon club, Chamber of Commerce, women's club, or other organization to provide the necessary observers. When this cannot be done, it is necessary to ask your patriotic friends, acquaintances, or other citizens to volunteer for the duty. You should arrange to get sufficient observers to insure the number necessary to man the observation post during all active periods.

(2) Fill in, in triplicate, Form No. 4 (Report of Chief Observers) as soon as you can. Place the original copy in

one of the War Department penalty envelopes furnished you and mail at once. We must have this completed copy of Form No. 4 by the date stamped on the front page of these instructions. (These penalty envelopes require no postage when used on Government business.) One copy of the filled in Form No. 4 should be given to the assistant chief observer for his files, and the remaining copy should be retained by you.

(3) Assign duty periods to each volunteer observer so that at least one will be on duty at all times during the period of active operations. Make out a schedule of duty periods and give each observer a copy. Tell each observer what is to be done in case a relieving observer does not arrive at the proper time, and in case an observer is unable to observe during a scheduled duty period.

d. Instruction of observers.—(1) Each observer should be furnished one copy of Form No. 5 (Instructions for Observers) and one copy of Form No. 1 (Flash Message Form).

(2) The instructions for observers and the flash message form should be studied together, and the chief observer should see that each observer is fully informed as to exactly what he is to do—how to call or dial the operator; what to say, and when to say it; and how to use the form provided. Observers should be cautioned to send flash messages in the sequence indicated on the form.

(3) Observers should be thoroughly acquainted with the orientation card supplied so that the direction of airplanes from the observation post can be readily determined (fig. 20).

(4) The present flash message form may be changed; therefore, no supply of these forms is available at present. Before active operation of the Aircraft Warning Service, the necessary number of flash message forms will be sent to each chief observer.

(5) Supplementary instructions will be issued from time to time. Special radio broadcasts will also be used for instruction and information to the Aircraft Warning Service. Card notices of such broadcasts will be issued in advance of such broadcasts.

(6) The confidential code name for each observation post which will be used in reporting flash messages will be sent to each observation post at a later date.

AIRCRAFT WARNING SERVICE

■ 4. FORM NO. 4 (REPORT OF CHIEF OBSERVERS).—*a.* The persons whose names appear below have volunteered to act as observers at the observation post (OP) for which I am responsible; to stand a previously agreed upon watch for aircraft during periods of active operation; to become familiar with the provisions of instructions for observers and with flash message forms; and to report aircraft by Government collect flash messages in accordance with the standard form and method of procedure when requested to do so.

NAME OF OBSERVER	OBSERVER'S ADDRESS
1. -----	-----
2. -----	-----
3. -----	-----
4. -----	-----
5. -----	-----
6. -----	-----
7. -----	-----
8. -----	-----
9. -----	-----
10. -----	-----
11. -----	-----
12. -----	-----
13. -----	-----
14. -----	-----
15. -----	-----
16. -----	-----

b. I will supervise the operations of the above observers in accordance with the provisions of instructions for chief observers; will make every effort to insure continuous manning of the observation post during the periods desired; will see that each of the above observers is familiar with the provisions of instructions for observers and with the use of flash message forms.

(Chief observer or assistant chief observer)

NOTE.—Please fill in this form with as many observers as you can obtain, or as may be necessary to man the observation post for the periods stated, and mail *as soon as possible* in the War Department franked penalty envelope provided.

■ 5. FORM NO. 5 (INSTRUCTIONS FOR OBSERVERS).—*a. General.*—(1) In order that every possible second will be saved in the reporting of aircraft to the air defense headquarters, and to insure that the essential information is transmitted in the most concise and expeditious manner, the flash type of message is used. It is important that every observer practice the preparation and telephoning of flash messages in order that he, or she, will be prepared to send the flash message with absolute minimum loss of time after the airplanes have been observed.

(a) A sample of flash message form is attached. Study this form in connection with the following notes and instructions. (See Form No. 1, appendix.)

(b) The body of the flash message consists of the information to be transmitted in the sequence of the numbered vertical columns. Each column must be checked or filled in to correspond with the information the observer has obtained. All of the information must be transmitted in accordance with a definite procedure.

(c) Your observation post is shown on a map at air defense headquarters. When you report, the air defense commander knows that aircraft was seen or heard near your post. As other observation posts report in succession, it is possible to determine the speed, course, and confirm information of the observed aircraft. Very accurate information as to the location of the aircraft is needed to permit accurate tracking. It is necessary that observers report the location of the airplanes with reference to observation post. The best way of doing this is to report the *direction* and *distance* of the airplanes from your observation post. Column 6 of the form gives the direction and column 7 gives the distance. *When the airplanes are directly over the observation post, you report "overhead" instead of giving a direction and a distance.*

(2) Detailed information regarding the flash message is given as follows:

Column 1. In this column either underline the appropriate word or give the exact number depending upon your observation. *Don't delay your report to get the exact number. Try to count the airplanes. If you can't count them, give your best estimate.*

Column 2. It is very difficult to identify airplanes. One of the easiest identifiable characteristics is the number of motors. If you saw the airplanes, use one of the three designations in this column according to your best observation. *If you can't tell how many motors the airplanes have, report all small airplanes as single motor and all large airplanes as multimotor.*

Column 3. Underline whether you *saw* or *heard* the airplanes.

Column 4. Underline the appropriate word corresponding to your observation. "Very low" and "very high" are extremes. When the airplanes are so high they are barely visible or can't be seen, report "very high." Report "very low" when the airplanes are just above the trees or ground. Airplanes are "low" when all of their details and markings are clear; "high" when the windows, markings, etc., cannot be seen. *Give your best estimate.*

The following can be used as a guide in reporting altitude of airplanes:

Very low.....	Below 1,000 feet.
Low.....	From 1,000 to 5,000 feet.
High.....	From 5,000 to 15,000 feet.
Very high.....	Above 15,000 feet.

Column 5. Your observation post code name will be sent to the chief observer of your observation post after it has been organized. This code name may be written in column 5 when you go on watch.

Column 6. Give the direction of the airplanes from your observation post when they were seen or heard by you. You can get a good idea of the direction of the enemy aircraft with the aid of the orientation card which should be permanently and correctly placed at your observation point. If you can't see the aircraft, make a good estimate of the direction.

Column 7. Indicate the distance of the airplanes you see or hear from your observation post. It will help if you pick out visible objects or landmarks whose distance from your observation post is known. Compare these subjects with the location of the aircraft for distance. *When you can't see the airplanes, estimate how far away from you they are.*

Your estimate is better than the commander's guess. He may be a hundred miles away. Give your best estimate.

Column 8. Give the direction in which the airplanes were traveling or headed. Your orientation card can help in this also.

If you can't fill in any column, say "Unknown."

b. Observer procedure.—The following is a detailed list of operations for each observer going on duty:

(1) Fill in several message blanks in advance with the information to be indicated in line 1 and column 5.

(2) Take a position at your observation post most favorable to see and hear airplanes.

(3) Immediately airplanes to be reported are seen or heard, note mentally all of the details in columns 1, 2, 3, 4, 6, 7 and 8. Do not wait to fill in this form but rush to your telephone at the observation post and call or dial the operator. When the operator says, "Number please," you reply, "Army, flash" followed by the telephone number of the observation post.

(4) Speak *slowly and distinctly*. Speak *directly* into the mouthpiece of the telephone.

(5) When the central operator hears the words "Army, flash," she immediately starts to put through a high priority, Government collect, long-distance call to the Army information center. While she is doing this, *underline* or otherwise properly fill in the flash message form. Be ready to give your flash message when an Army operator answers and says, "Army, go ahead, please."

(6) When the Army operator says, "Army, go ahead, please," you start giving your flash message. Talk in an even tone, speaking as distinctly as possible. Do not talk too fast. You start your actual flash message by saying "Army, flash" followed by the proper words you have marked or entered in columns 1 to 8, inclusive, on your flash message form.

(7) When you have finished your flash message, wait until the Army operator has said "Check, thank you." When the Army operator says "Check, thank you," hang up at once in order to clear the lines for other messages.

(8) After you have hung up, retain the flash message form you have transmitted in; hand it to the chief observer for file. The chief observer keeps a record of all actual flash messages sent.

NOTES

1. Study and become familiar with the detailed sequence of the flash message form. Study the orientation card which is located at your observation post and become familiar with the direction of landmarks near your observation post.

2. *Speed* in reporting an observed flight is of extreme importance. It is assumed that you have started to telephone your report within 15 seconds after making the observation. It is of extreme importance that as little time as possible be lost in your observation of aircraft, getting to the telephone and being ready to send your message. The telephone personnel are trained especially to handle your reports and have also established a minimum time by special telephone procedure. If you can do your part in 15 seconds or less, we can depend on a very short over-all time from observation to the Army plotting board.

■ 6. FORM NO. 6 (RAID NUMBER ASSIGNMENT SHEET).

Place.....
 Raid clerk name.....
 Date.....
 Hours.....

No.	Remarks	No.	Remarks
1.	26.
2.	27.
3.	28.
4.	29.
5.	30.
6.	31.
7.	32.
8.	33.
9.	34.
10.	35.
11.	36.
12.	37.
13.	38.
14.	39.
15.	40.
16.	41.
17.	42.
18.	43.
19.	44.
20.	45.
21.	46.
22.	47.
23.	48.
24.	49.
25.	50.

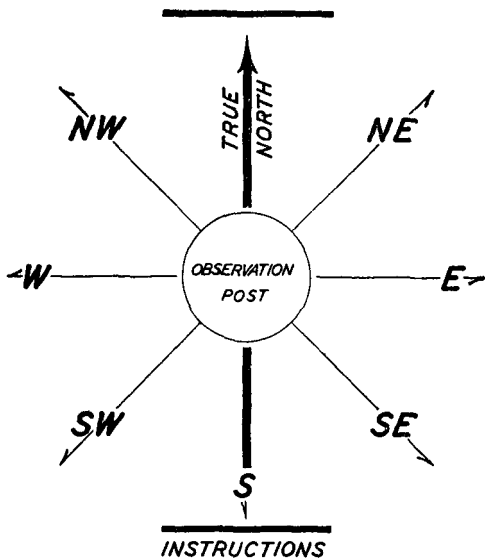

ORIENT THIS CARD IN SOME CONVENIENT LOCATION WHERE IT CAN BE SEEN BY THE OBSERVERS. IT WILL THEREBY PERMIT THEM TO FIX IN THEIR MINDS DIRECTIONS FROM THE OBSERVATION POST

FIGURE 20.—Orientation card.

INDEX

	Paragraph	Page
Active air defense:		
Components -----	9	6
Definition -----	2	1
Responsibility -----	6	3
Air defense areas:		
Areas of regions -----	9	6
Warning districts -----	28	19
Air defense commander:		
Command -----	9	6
Responsibility -----	6, 9	3, 6
Air defense grid systems -----	31, 68	22, 57
Air force (fixed echelon) -----	6	3
Aircraft identification:		
Aid to -----	41	37
Identification by observer -----	29	19
Aircraft Warning Service:		
Chief functions -----	2	1
Coordination -----	5	2
Definition -----	2	1
Factors effecting -----	9	6
Fixed -----	6, 10	3, 8
Functions -----	5	2
Organization -----	4, 6, 9, 10	2, 3, 6, 8
Mission -----	4	2
Mobile -----	10	8
Purpose -----	1	1
Responsibility -----	6	3
Systems -----	9	6
Antiaircraft artillery officer -----	103	85
Army liaison officer -----	104	87
Bombardment command liaison officer -----	110	93
Civil air raid officer -----	102	83
Civil air raid warning -----	6	3
Command post:		
Center of gravity -----	9	6
Information center -----	9, 42	6, 38
Location -----	9	6
Communication systems:		
Agencies -----	53	48
Aircraft warning systems of communication -----	51, 52	47
Coordination -----	55	49
Employment -----	52	47
Factors governing employment -----	9, 56	6, 49
Messenger service -----	62	52
Observers -----	37	30
Panels -----	61	52
Purpose -----	9	6
Responsibility -----	54	48
Radio -----	60	52
Telegraph sets TG-5 and TG-5-A -----	59	51
Teletypewriter -----	58	51
Wire lines -----	57	51

INDEX

	Paragraph	Page
Controller:		
Duties.....	97	75
General mission.....	98	78
Location.....	97	75
Switchboard.....	97	75
Federal Communications Commission liaison officer	111	93
Filter board section	16	11
Filter center:		
Alternate.....	44, 48	45, 46
Definition.....	8	6
Equipment.....	69, 70	58
Mezzanine personnel.....	47	46
Primary.....	44	45
Purpose.....	9	6
Filtering:		
Altitude.....	74	61
Course.....	78	62
Friend or enemy.....	77	61
Number of planes.....	76	61
Replacing pips with arrows.....	80	62
Type of planes.....	75	61
Unknown data.....	79	62
Floor supervisor:		
Duties.....	84	63
Equipment.....	83	63
Log.....	84	63
Frontier Aircraft Warning Service (fixed echelon)	56	49
General air defense:		
Definition.....	2	1
Air defense command.....	9	6
Organization responsibility.....	6	3
Training.....	37	30
Grid systems	68	57
Ground observation platoon	26	16
Headquarters platoon	17, 19, 20	11, 13, 14
Information and filter center personnel:		
Antiaircraft officer.....	103	85
Bombardment command liaison officer.....	110	93
Civil air raid warning officer.....	102	83
Controller.....	97	75
Federal Communication Commission liaison officer.....	111	93
General.....	95	72
Intercept officer.....	106	88
Liaison officers.....	104	87
Pursuit officer.....	99	79
Radar officer.....	101	81
Radar plotters.....	90	68
Radio A officer.....	100	79
Raid clerk.....	96	72
Rescue officer.....	108	93
Status board plotters.....	42, 107	38, 99
Weather officer.....	105	87

INDEX

	Paragraph	Page
Information center:		
Definition -----	2	1
Installation -----	42	38
Purpose -----	9	6
Intercept board:		
Description -----	43, 106	42, 88
Duties -----	106	88
Enemy plotter -----	106	88
Intercept officer's duties -----	106	88
Sequence in telling -----	89	67
Teller's equipment -----	89, 107	67, 90
Teller's information -----	89, 106	67, 88
Tellers to intercept board -----	89, 106	67, 88
Intercept board section -----	16	11
Interceptor command, mobile aircraft warning service -----	6	3
Interceptor commander:		
Definition -----	2	1
Responsibility -----	6, 10	3, 8
Liaison officers -----	104	87
Local air defense definition -----	2	1
Maps:		
Aircraft Warning Service -----	31	22
Observer's -----	37	30
Medical detachment -----	26	16
Message center platoon -----	17	11
Messages:		
Air raid warning -----	102	83
Departure and arrival -----	58	51
Flash -----	36, 38	29, 34
Messenger service -----	62	52
Method of filtering -----	72	60
Mezzanine floor:		
Construction -----	42	38
Interceptor command post -----	43	42
Personnel positions -----	42	38
Military observers:		
Cooperation -----	7	5
Limitations -----	28	19
Military units:		
General -----	10	8
Headquarters and headquarters company -----	13	10
Plotting battalion, regiment -----	14	11
Battalion, separate -----	22	15
Regiment -----	10, 12	8, 10
Signal communication company -----	17	11
Signal headquarters and headquarters com- pany: -----		
Battalion, separate -----	23	15
Inceptor command -----	21	14
Plotting battalion -----	15	11
Reporting battalion -----	19	13
Signal plotting company: -----		
Battalion, separate -----	10, 24	8, 16
Frontier -----	10, 26	8, 16
Regiment -----	16	11

INDEX

Military units—Continued.

	Paragraph	Page
Signal reporting company:		
Battalion, regiment.....	18	13
Battalion, separate.....	25	16
Frontier.....	27	19
Mobile task force responsibility.....	6	3
Naval liaison officer.....	104	87
Nonmilitary agencies:		
Alerting.....	37	30
Collective training.....	29	19
Definition.....	2	1
First phase of training.....	29	19
General.....	28, 36	19, 29
General guide for procurement.....	6, 28, 36	3, 19, 29
Observers.....	29	19
Organization.....	36, 37	29, 30
Responsibility.....	6	3
Time of collective training.....	29	19
Training of personnel.....	28, 29	19
Observation board.....	42	38
Observation board plotters.....	38	65
Observation posts:		
Alerting.....	37	30
Assistant chief observer.....	37	30
Chief observer.....	37	30
Code names.....	37	30
Definition.....	8	6
Forms.....	37	30
Location.....	37	30
Number of observers.....	37	30
Observers procedure.....	39	36
Organizing.....	37	30
Outside observers.....	37	30
Qualifications of observer.....	37	30
Reporting.....	37, 38, 40	30, 34, 37
Responsibility of observer.....	37	30
Visual or aural.....	8	6
Observation systems:		
Alerting.....	37	30
Nontechnical.....	37	30
Organization.....	37	30
Technical.....	30, 31	22
Observer, definition.....	36	29
Operation of patching switchboard.....	93	70
Operation of telephone equipment (filter center).....	64	54
Operations board section.....	16	11
Operations room.....	42	38
Organization of air force theater of operations.....	56	49
Orientation.....	38	34
Oscilloscope operator.....	30	22
Overlap areas.....	46	45
Overlap teller.....	87	46
Passive air defense:		
Definition.....	2	1
Nonmilitary.....	37	30
P. B. X. operation, administrative.....	94	71
Pips, plotting.....	65	55

INDEX

	Paragraph	Page
Plotters:		
Alternate.....	63	53
Answering calls.....	65	55
Radar.....	30	22
Operation.....	64	54
Overlap calls.....	67	56
Plotting calls.....	65	55
Status board.....	107	90
Plotter's equipment.....	65	55
Plotting by grid coordinates.....	68	57
Primary filter board.....	46	45
Primary filter room.....	45	45
Pursuit officer's duties.....	99	79
Radar:		
Additional transportation.....	32	24
Antenna mount (trailer).....	32, 33	24
Azimuth motor.....	32	24
Board section.....	16	11
Definition.....	8	6
Function.....	9, 31	6, 22
Installation.....	32, 35	24, 27
Limit of search.....	31	22
Location.....	31, 33	22, 24
Operation truck K-30.....	32, 33	24
Plotter.....	30	22
Plotting grid coordinates.....	68	57
Power supply truck K-31.....	32, 33	24
Power winch.....	32	24
Stake body truck K-33.....	32	24
Supply and training responsibility.....	9	6
Tactical control.....	9, 30	6, 22
Time factor.....	9	6
Training on location.....	31	22
Transmission line.....	33, 35	24, 27
Radar board.....	42	38
Radar officer:		
Definition.....	30	22
Duties.....	101	81
Location.....	101	81
Radar control.....	31	22
Telephone equipment.....	101	81
Radar plotters:		
General.....	88	65
Plotting.....	30, 88, 90	22, 65, 68
Telephone equipment.....	88	65
Radar tellers.....	91, 92	68, 69
Radio A officer.....	100	79
Raid clerk.....	96	72
Regional commander:		
Areas of regions.....	9	6
Responsibility.....	9, 10	6, 8
Tactical control of pursuit.....	9	6
Regional signal officer:		
Duties.....	10, 57	8, 51
Responsibility.....	6, 9, 36, 54, 109	3, 6, 29, 48, 93
Section.....	26	16
Regional control officer's duties.....	9	6

INDEX

	Paragraph	Page
Repair platoon.....	19	13
Reporting districts.....	63	53
Reporting platoon details.....	34, 35	26, 27
Rescue officer.....	108	93
Status board.....	107	90
Supply and transportation section.....	16	11
System of filtering:		
Arrow pips.....	65, 71	55, 59
Clock used.....	71	59
Filtering speed.....	73	60
Targets:		
Coordinates.....	31	22
Display stand.....	69, 70, 71	58, 59
Tellers:		
Definition.....	30	22
Overlay from adjoining filter board.....	87	65
Sequence of telling to overlap plotters.....	85	64
To intercept board.....	86	64
To operations board.....	85	64
To overlap tellers.....	87	65
Tracking.....	38	34
Turret supervisors:		
Duties.....	82	63
Equipment.....	81	62
Variations from standard procedure.....	1	1
Weather board.....	43	42
Weather officer.....	105	87
Wire platoon.....	17	11

